

GV-Video Server

User's Manual



Before attempting to connect or operate this product, please read these instructions carefully and save this manual for future use.



© 2018 GeoVision, Inc. All rights reserved.

Under the copyright laws, this manual may not be copied, in whole or in part, without the written consent of GeoVision.

Every effort has been made to ensure that the information in this manual is accurate. GeoVision, Inc. makes no expressed or implied warranty of any kind and assumes no responsibility for errors or omissions. No liability is assumed for incidental or consequential damages arising from the use of the information or products contained herein. Features and specifications are subject to change without notice.

Note: No memory card slot or local storage function for Argentina.

GeoVision, Inc.
9F, No. 246, Sec. 1, Neihu Rd.,
Neihu District, Taipei, Taiwan
Tel: +886-2-8797-8377
Fax: +886-2-8797-8335
<http://www.geovision.com.tw>

Trademarks used in this manual: *GeoVision*, the *GeoVision* logo and GV series products are trademarks of GeoVision, Inc. *Windows* is the registered trademarks of Microsoft Corporation.

February, 2018

Preface

Welcome to the *GV-Video Server User's Manual*.

GV-Video Server has a series of models designed to meet different needs. Each model has its own firmware that can only be used on the specific model. This Manual is designed for the following models and firmware version:

Model	Firmware Version
GV-VS04H	1.08
GV-VS11	1.05
GV-VS12	1.09
GV-VS14	1.03
GV-VS2400	1.07
GV-VS2401	1.00
GV-VS2420	1.07
GV-VS2800	1.03
GV-VS2820	1.03
GV-VS21600	1.00

IMPORTANT: For better recording efficiency and stability of GV-Video Server, after upgrading the firmware to the above version, it is required to **format the storage device**. To format the storage device, be sure to back up the data first and see [4.8.3 Storage Settings](#) for how to format the storage device.

Caution

- GV-Video Server is designed only for indoor usage.

Contents

Chapter 1 Introduction	1
1.1 Models and Features	1
1.2 Packing List	3
1.2.1 GV-VS04H / 14.....	3
1.2.2 GV-VS11	3
1.2.3 GV-VS12	4
1.2.4 GV-VS2420 / 2400.....	4
1.2.5 GV-VS2401	5
1.2.6 GV-VS2820 / 2800.....	5
1.2.7 GV-VS21600	6
1.3 Compatible Products and System Requirements	7
1.3.1 Compatible GeoVision Software	7
1.3.2 System Requirements.....	8
1.4 PoE Support	8
1.5 GPS Support.....	9
1.6 Options	10
1.7 Physical Description.....	13
1.7.1 Front View	13
1.7.2 Rear View.....	20
Chapter 2 Getting Started	25
2.1 Installing on a Network.....	25
2.2 Checking the IP Address	27
2.3 Changing the IP Address	28
2.4 Configuring the Basics	29
Chapter 3 Accessing the GV-Video Server	30
3.1 Accessing Your Surveillance Images	30
3.2 Functions Featured on the Main Page	32
3.2.1 The Live View Window.....	33
3.2.2 The Control Panel of the Live View Window	35
3.2.3 Snapshot of a Live Video	37
3.2.4 Video Recording	37
3.2.5 Picture-in-Picture and Picture-and-Picture View.....	37
3.2.6 Alarm Notification.....	40
3.2.7 Video and Audio Configuration	41
3.2.8 Remote Configuration	41

3.2.9	Camera Name Display.....	42
3.2.10	Image Enhancement.....	42
3.2.11	PTZ Control	43
3.2.12	Visual PTZ.....	44
3.2.13	I/O Control	45
3.2.14	Visual Automation.....	46
3.2.15	Network Status	46

Chapter 4 Administrator Mode47

4.1	Video and Motion.....	51
4.1.1	Multicast	51
4.1.2	Video Settings	52
4.1.3	Motion Detection.....	59
4.1.4	Privacy Mask.....	61
4.1.5	Text Overlay	62
4.1.6	Tampering Alarm	63
4.1.7	Visual Automation.....	65
4.1.8	Video Channel Source Settings	66
4.2.	Digital I/O & PTZ.....	67
4.2.1	PTZ Settings.....	68
4.2.2	Input/Output Settings	69
4.2.3	GPS/Wiegand.....	72
4.2.4	Buzzer	75
4.3	Events & Alerts	76
4.3.1	E-mail	77
4.3.2	FTP.....	79
4.3.3	Center V2	81
4.3.4	Vital Sign Monitor.....	83
4.3.5	GV-GIS.....	85
4.3.6	Backup Center	87
4.3.7	Video Gateway/Recording Server	89
4.3.8	ViewLog Server	91
4.3.9	3GPP/RTSP/ONVIF.....	92
4.4	Monitoring.....	94
4.5	Recording Schedule.....	96
4.5.1	Recording Schedule Settings.....	96
4.5.2	I/O Monitoring Settings	97
4.6	Remote ViewLog	97
4.7	Network	98

4.7.1	LAN	98
4.7.2	Wireless-Client Mode.....	100
4.7.3	Advanced TCP/IP	102
4.7.4	UMTS	106
4.7.5	Multicast	108
4.7.6	IP Filter	109
4.7.7	SNMP Setting	110
4.8	Management.....	111
4.8.1	Date and Time Settings	111
4.8.2	GPS Maps Settings	113
4.8.3	Storage Settings	114
4.8.4	User Account	117
4.8.5	Log Information.....	118
4.8.6	System Log.....	119
4.8.7	Tools.....	120
4.8.8	Language.....	122

Chapter 5 Recording and Playback123

5.1	Recording	123
5.2	Playback.....	123
5.2.1	Playback Using USB Mass Storage Device	124
5.2.2	Playback over Network	125
5.2.3	Playback of GPS Tracks	127

Chapter 6 Advanced Applications129

6.1	Upgrading System Firmware.....	129
6.1.1	Using the Web Interface	130
6.1.2	Using the IP Device Utility.....	131
6.2	Backing Up and Restoring Settings.....	132
6.2.1	Backing Up the Settings.....	132
6.2.2	Restoring the Settings.....	133
6.3	GPS Tracking	134
6.4	Restoring to Factory Default Settings	136
6.5	Verifying Watermark.....	137
6.5.1	Accessing AVI Files	137
6.5.2	Running Watermark Proof	137
6.5.3	The Watermark Proof Window	138

Chapter 7	DVR / NVR / VMS.....	139
7.1	Setting Up GV-Video Server on GV-DVR / NVR	141
7.1.1	Customizing GV-Video Server Settings	144
7.2	Setting Up GV-Video Server on GV-VMS	146
7.3	Receiving Cardholder Data from Video Server.....	149
7.4	Remote Monitoring with Multi View	151
7.5	Remote Monitoring with E-Map.....	152
Chapter 8	CMS Configurations.....	155
8.1	Center V2	155
8.2	Vital Sign Monitor.....	157
8.3	Dispatch Server	158
Chapter 9	Auxiliary Device Connectors	159
9.1	GV-VS04H / 14 / 2420 / 2400 / 2401 / 2820 / 2800 / 21600	159
9.1.1	Pin Assignment.....	160
9.1.2	Relay Output.....	162
9.2	GV-VS11	163
9.3	GV-VS12	164
9.3.1	Pin Assignment.....	164
9.3.2	RS-232 Terminal Block.....	165
Chapter 10	Mobile Phone Connection	166
Appendix.....		167
A.	Settings for Internet Explore 8 or later	167
B.	Supported Wireless LAN USB Adaptor.....	167
C.	Supported Mobile Broadband Device	168
D.	The RTSP Command	168
E.	Supported PTZ Cameras.....	169
F.	The CGI Command	171
G.	Default Port Value	171

Chapter 1 Introduction

The GV-Video Server allows the conversion of any analog camera into a fully functional IP camera. It streams the real-time digital video over the Internet in the same way that current IP cameras do. With the analog cameras attached to the GV-Video Server, you can see camera images through a Web browser anytime and anywhere. And with the GV-Video Server connected to the GV-DVR / NVR / VMS, your existing surveillance system can be upgraded and networked into a new IP surveillance system.

1.1 Models and Features

The GV-Video Server has the following models:

GV-VS04H	<ul style="list-style-type: none"> - 4-channel video inputs - Records up to 120 (NTSC) / 100 (PAL) fps at the D1 resolution - H.264 video compression - Two-way audio - GPS tracking / Wiegand access control support
GV-VS11	<ul style="list-style-type: none"> - 1-channel video input - Records up to 30 (NTSC) / 25 (PAL) fps at the D1 resolution - H.264, MPEG4 and MJPEG video compression - One-way audio - Dual streams
GV-VS12	<ul style="list-style-type: none"> - 2-channel video inputs - Records up to 60 (NTSC) / 50 (PAL) fps at the D1 resolution - MPEG4, MJPEG and H.264 video compression - Two-way audio - GPS tracking support
GV-VS14	<ul style="list-style-type: none"> - 4-channel video inputs - Records up to 120 (NTSC) / 100 (PAL) fps at the D1 resolution - H.264 and MJPEG video compression - Two-way audio - GPS tracking / Wiegand access control support - Dual streams

GV-VS2400 (TVI)	<ul style="list-style-type: none"> - 4-channel video inputs - TVI / CVBS signal - Records up to 120 (NTSC) / 100 (PAL) fps at HD-TV 1080p resolution - H.264 - Two-way audio - Dual streams
GV-VS2401 (Combo)	<ul style="list-style-type: none"> - 4-channel video inputs - 4-channel combo 18 fps at 3 MP and 15 fps at 4 MP - Combo / CVBS signal - Records up to 120 (NTSC) / 100 (PAL) fps at HD-Combo 1080p resolution - H.264 - Two-way audio - Dual streams
GV-VS2420 (AHD)	<ul style="list-style-type: none"> - 4-channel video inputs - AHD / CVBS signal - Records up to 120 (NTSC) / 100 (PAL) fps at AHD 1080p resolution - H.264 - Two-way audio - Dual streams
GV-VS2800 (TVI)	<ul style="list-style-type: none"> - 8-channel video inputs - 8-channel TVI 18 fps at 3 MP and 15 fps at 4 MP - TVI / CVBS signal - Records up to 240 (NTSC) / 200 (PAL) fps at HD-TV 1080p resolution - H.264 - Two-way audio - Dual streams
GV-VS2820 (AHD)	<ul style="list-style-type: none"> - 8-channel video inputs - 8-channel AHD 18 fps at 3 MP and 15 fps at 4 MP - AHD / CVBS signal - Records up to 240 (NTSC) / 200 (PAL) fps at HD-AHD 1080p resolution - H.264 - Two-way audio - Dual streams
GV-VS21600 (Combo)	<ul style="list-style-type: none"> - 16-channel video inputs - Combo / CVBS signal - Records up to 240 (NTSC) / 200 (PAL) fps at HD-Combo 1080p resolution - H.264 - Two-way audio - Dual streams

1.2 Packing List

1.2.1 GV-VS04H / 14



1. GV-VS04H / GV-VS14
2. AC Power Cord
3. DC Male-to-Male Cable (for powering the camera through GV-Video Server)
4. Power Adaptor
5. Wall Hook
6. Conical Anchor x 4
7. Screw x 4
8. 3.5 mm Stereo to RCA Cable x 2
9. GV-Video Server Software CD/DVD
10. GV-NVR Software CD/DVD

Note: The DC Male-to-Male Cable is used to power the camera through the GV-Video Server. You can also optionally purchase three more DC Male-To-Male Cables and one DC 1-Male to 4-Female Cable to power four cameras through the GV-Video Server.



DC 1-Male to 4-Female Cable DC Male-to-Male Cable

1.2.2 GV-VS11



1. GV-VS11
2. Power Adaptor
3. GV-Video Server Software CD/DVD
4. GV-NVR Software CD/DVD

1.2.3 GV-VS12



1. GV-VS12
2. AC Power Cord
3. Power Adaptor
4. I/O Cable with RJ-45 Connector
5. Wall Hook
6. Conical Anchor x 4
7. Screw x 4
8. Sticker (for positioning conical anchors)
9. GV-Video Server Software CD/DVD
10. GV-NVR Software CD/DVD

1.2.4 GV-VS2420 / 2400

1. GV-VS2420 / 2400



2. AC Power Cord



3. Power Adaptor



4. Download Guide
5. Warranty Card

1.2.5 GV-VS2401

- 1. GV-VS2401



- 2. AC Power Cord



- 3. Power Adaptor



- 4. Download Guide

- 5. Warranty Card

1.2.6 GV-VS2820 / 2800

- 1. GV-VS2820 / 2800



- 2. AC Power Cord



- 3. Power Adaptor



- 4. Download Guide

- 5. Warranty Card

1.2.7 GV-VS21600

1. GV-VS21600



2. AC Power Cord



3. Power Adaptor



4. DVI to 16 Video BNC Breakout Cable



5. DVI to 16 Audio RCA Breakout Cable



6. Download Guide

7. Warranty Card

1.3 Compatible Products and System Requirements

1.3.1 Compatible GeoVision Software

This section introduces the compatible applications for **GV-VS2420 / 2400 / 2401 / 2820 / 2800 / 21600**.

	Compatible Software	VS2420 / 2400	VS2820 / 2800	VS2401 / 21600
Surveillance System and Network Storage	GV-DVR / NVR	V8.6.2 with patch files or later		V8.7.4.0 with patch files or later
	GV-VMS	V15.10 with patch files or later	V16.10.3.0 with patch files or later	V16.11.0.0 with patch files or later
	GV-Backup Center	V1.2.0.0 or later		
	GV-Control Center	V3.4.0.0 with patch files or later		
	GV-Center V2	V16.10.0 with patch files or later		V16.11.0 with patch file or later
	GV-Recording Server / Video Gateway	V1.3.0.0 with patch files or later		
	GV-Redundant / Failover Server	V1.1.0.0 with patch files or later		
	GV-Remote ViewLog	V16.11.0 or later		V16.11.0 with patch file or later
	Mobile App	GV-Eye	V2.0 or later	V2.3 or later
Edge Recording	GV-Edge Recording Manager for Windows	V1.2.0.0 with patch files or later		V1.3.0.0 with patch files or later

1.3.2 System Requirements

To access the Web interface of the GV-Video Server, ensure your PC is in good network connection and use one of the following Web browsers:

For GV-VS04H / 11 / 12 / 14

- Microsoft Internet Explorer 7.x or later

For GV-VS2420 / 2400 / 2401 / 2820 / 2800 / 21600

- Microsoft Internet Explorer 8.x or later
- Google Chrome
- Mozilla Firefox
- Safari
- Microsoft Edge

Note:

1. For the users of **Internet Explorer 8 or later**, additional settings are required. For details, see *Appendix A*.
 2. **Internet Explorer 10** is only supported by GV-VS11 version 1.05, GV-VS12 version 1.09 and GV-VS14 version 1.03.
 3. For users of non-IE browsers using GV-VS2420 / 2400 / 2401 / 2800 / 2820 / 21600, download **GV-Web Viewer** to access full functioning user interface. For details, see *3.1 Accessing Your Surveillance Images*.
-

1.4 PoE Support

The models supporting PoE (Power over Ethernet) include:

- GV-VS04H and GV-VS12

When the PoE (Power over Ethernet) function is used, please note:

- The I/O terminal functions will not work. Don't connect any devices to the I/O terminal block on the rear panel of the unit.
- External power supply is required for USB storage device when used for recording.

See "Power over Ethernet" in *Specifications* later in this manual before purchasing a PoE adaptor.

1.5 GPS Support

Attached with the GV-GPS Receiver, the GV-Video Server allows you to perform vehicle tracking on Google Maps. The models supporting GPS function include:





- GV-VS04H, GV-VS12 and GV-VS14.





Different models of the GV-Video Server support different interfaces:

- **UART:** GV-VS04H and GV-VS14
- **RS-232:** GV-VS12

1.6 Options

Optional devices can expand your GV-Video Server's capabilities and versatility. Contact your dealer for more information.

<p>GV-GPS Receiver</p> 	<p>GV-GPS Receiver is a Global Position System receiver. With the GV-GPS Receiver, you can perform GPS tracking and location verification of the GV-Video Server. Two types of interfaces are available: UART (for GV-VS04H / 14) and RS-232 (for GV-VS12).</p> <p>Note: GV-GPS Receiver is only supported by GV-VS04H / 12 / 14.</p>
<p>GV-Relay V2</p> 	<p>Working with a GV-Relay V2, the GV-Video Server is capable of driving the loads of relay outputs over 5 volts.</p>
<p>GV-WiFi Adaptor V2</p> 	<p>Only supported by GV-VS2420 / 2400 (Firmware Version 1.03 or later) / 2401 / 2820 / 2800 / 21600. The WiFi Adaptor V2 is designed to connect GV IP devices, such as GV-Video Server, to the wireless network.</p>
<p>GV-PA191 PoE Adaptor</p> 	<p>GV-PA191 is designed to provide power to the IP device through a single Ethernet cable. GV-PA191 is only supported by GV-VS04H / 12.</p>
<p>GV-VR605A DC Voltage Regulator</p> 	<p>With a GV-VR605A, you can install the GV-Video Server in the car. GV-VR605A will supply and maintain a 12V voltage to the GV-Video Server and its connected cameras.</p> <p>Note: GV-VR605A is only supported by GV-VS04H / 11 / 12 / 14.</p>

<p>DC Male-to-Male Cable DC 1-Male to 4-Female Cable</p>  <p>DC 1-Male to 4-Female Cable DC Male-to-Male Cable</p>	<p>Only available for GV-VS2420 / 2400 / 2401, the DC Male-to-Male Cable is used to power the camera through the GV-Video Server.</p> <p>For instance, you can purchase four DC Male-to-Male Cables and one DC 1-Male to 4-Female Cable to power four cameras through the GV-Video Server.</p>
<p>3.5 mm Stereo to RCA Cable</p> 	<p>Only supported by GV-VS2401 / 2820 / 2800, the 3.5 mm Stereo to RCA Cable is served as an audio adapter for microphones with RCA connectors.</p>
<p>Wall Hook</p> 	<p>Only supported by GV-VS2420 / 2400 / 2401 / 2820 / 2800 / 21600, the Wall Hook is used to mount the device to the wall.</p>
<p>Din-rail Hook</p> 	<p>Only supported by GV-VS2420 / 2400 / 2401 / 2820 / 2800 / 21600, the Din-rail Hook is used to mount the device to a 35-mm (1.38-in) DIN rail.</p>
<p>Rack Mount</p> 	<p>Only supported by GV-VS2420 / 2400 / 2401 / 2820 / 2800 / 21600, the Rack Mount is used to mount up to 3 GV-VS2420 / 2400 / 2401 or 2 GV-VS2820 / 2800 / 21600 video servers to a 19-inch (482.6-mm) rack.</p>
<p><i>Access Control Series</i></p> <p><i>GV-Video Server can work with the Wiegand-interface card reader to send cardholder data to central monitoring stations, such as Center V2 and Vital Sign Monitor, as well as GV-DVR / NVR. The following devices are only supported by GV-VS04H / 14.</i></p>	

GV-Reader	<p>GV-Reader includes transmit-receive antenna and electronics. Featured with the Wiegand output, the unit is compatible with any standard access control panel.</p>
GV-R1352 Card Reader 	<p>The GV-R1352 is a card reader designed to recognize identification cards. Featured with the Wiegand output, the unit can be connected to any standard access control panel. GV-R1352 comes with a weather-sealed and IP66 compliant housing for outdoor use.</p>

1.7 Physical Description

This section identifies the various components of the GV-Video Server.

1.7.1 Front View

1.7.1.1 GV-VS04H / 14

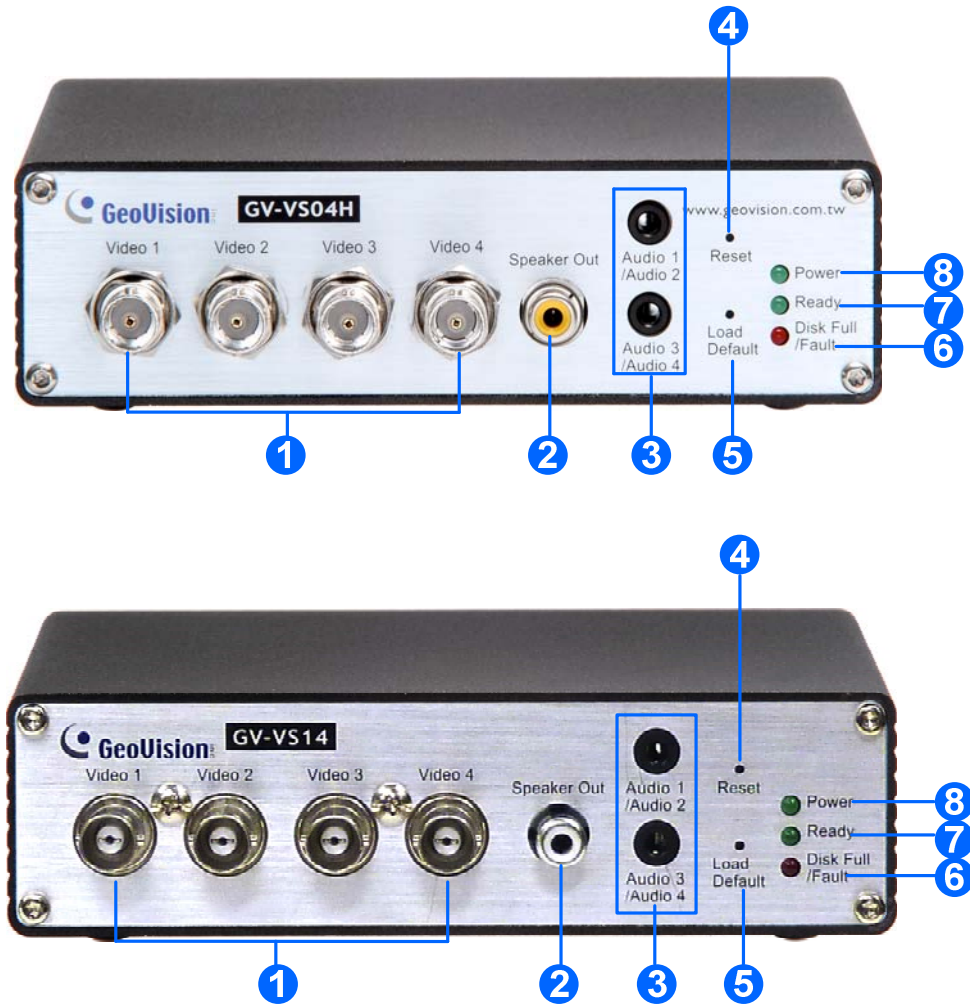

Figure 1-1

No.	Name	Function
1	Video Input	4 plugs for video inputs.
2	Speaker Output	A plug for the speaker device.
3	Audio Input	Each plug is for 2 audio inputs.
4	Reset	It reboots the GV-Video Server, and keeps all current configurations.
5	Default Button	It resets all configurations to their factory settings. See 6.4 <i>Restoring to Factory Default Settings</i> .
6	Disk Full/Fault LED	This LED is on, indicating the hard drive is full or faulty.
7	Ready LED	This LED is on, indicating the GV-Video Server is ready for connection.
8	Power LED	This LED is on, indicating the power is supplied.

1.7.1.2 GV-VS11



Figure 1-2

No.	Name	Function
1	Video Input	1 plug for video input.
2	Default Button	It resets all configurations to their factory settings. See 6.4 <i>Restoring to Factory Default Settings</i> .
3	Audio Input	1 plug for audio input.
4	Ready LED	This LED is on, indicating the GV-Video Server is ready for connection.
5	Power LED	This LED is on, indicating the power is supplied.

1.7.1.3 GV-VS12



Figure 1-3

No.	Name	Function
1	USB Port	1 USB port for installing the portable storage device.
2	Speaker Output	A plug for the speaker device.
3	Audio Input	2 plugs for audio inputs.
4	Video Input	2 plugs for video inputs.

1.7.1.4 GV-VS2420 / 2400

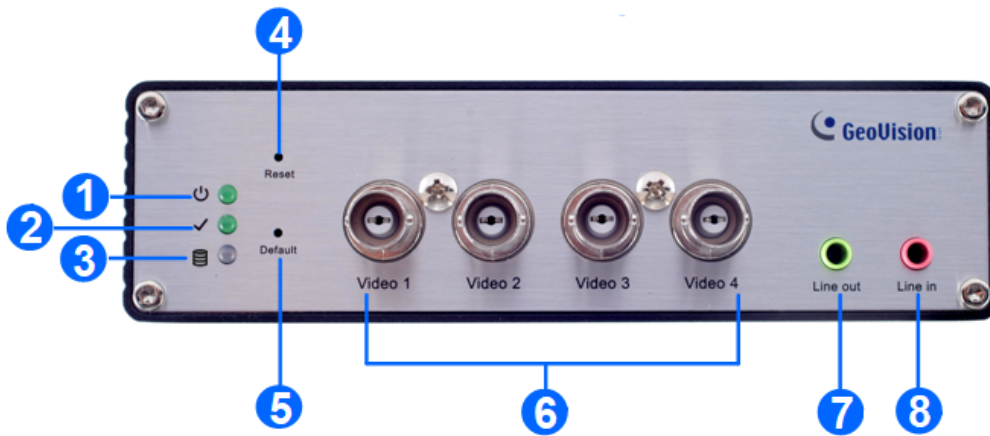

Figure 1-4

No.	Name	Function
1	Power LED	This LED is on, indicating the power is supplied.
2	Ready LED	This LED is on, indicating the GV-Video Server is ready for connection.
3	Disk Full/Fault LED	This LED is on, indicating the hard drive is full or faulty.
4	Reset	It reboots the GV-Video Server and keeps all current configurations.
5	Default Button	It resets all configurations to their factory settings. See 6.4 <i>Restoring to Factory Default Settings</i> .
6	Video Input	4 plugs for video inputs.
7	Line Out	A plug for Video 1 speaker device.
8	Line In	A plug for Video 1 audio input.

Note: When transmitting video signals over a long distance, it is highly recommended to use 5C-FB coaxial cables or above to minimize the degradation of image quality. The transmission distance should be within 300 m (984 ft).

1.7.1.5 GV-VS2401

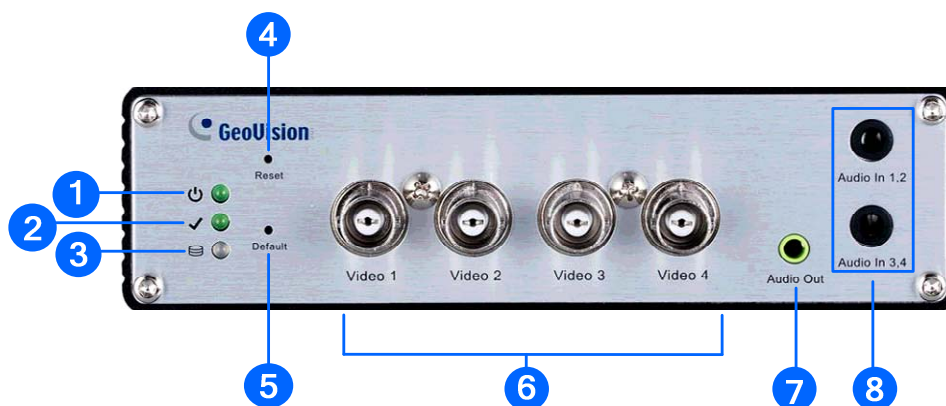

Figure 1-5

No.	Name	Function
1	Power LED	This LED is on, indicating the power is supplied.
2	Ready LED	This LED is on, indicating the GV-Video Server is ready for connection.
3	Disk Full/Fault LED	This LED is on, indicating the hard drive is full or faulty.
4	Reset	It reboots the GV-Video Server and keeps all current configurations.
5	Default Button	It resets all configurations to their factory settings. See 6.4 <i>Restoring to Factory Default Settings</i> .
6	Video Input	4 plugs for video inputs.
7	Audio Out	A plug for the speaker device.
8	Audio In	Each plug is for 2 audio inputs.

Note: When transmitting video signals over a long distance, it is highly recommended to use 5C-FB coaxial cables or above to minimize the degradation of image quality. The transmission distance should be within 300 m (984 ft).

1.7.1.6 GV-VS2820 / 2800

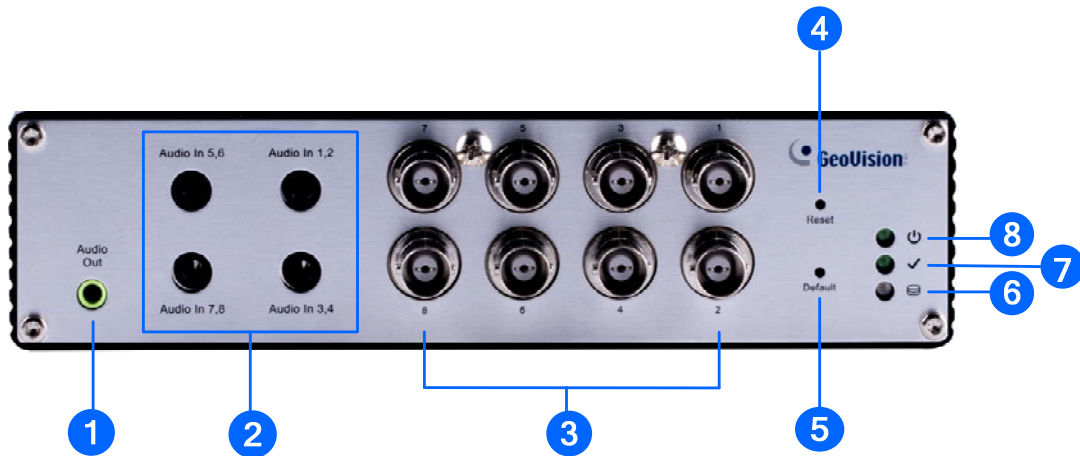

Figure 1-6

No.	Name	Function
1	Audio Out	A plug for the speaker device.
2	Audio In	4 plugs for max. 8 audio inputs.
3	Video Input	8 plugs for video inputs.
4	Reset	It reboots the GV-Video Server, and keeps all current configurations.
5	Default Button	It resets all configurations to their factory settings. See 6.4 <i>Restoring to Factory Default Settings</i> .
6	Disk Full/Fault LED	This LED is on, indicating the hard drive is full or faulty.
7	Ready LED	This LED is on, indicating the GV-Video Server is ready for connection.
8	Power LED	This LED is on, indicating the power is supplied.

Note: When transmitting video signals over a long distance, it is highly recommended to use 5C-FB coaxial cables or above to minimize the degradation of image quality. The transmission distance should be within 300 m (984 ft).

1.7.1.7 GV-VS21600

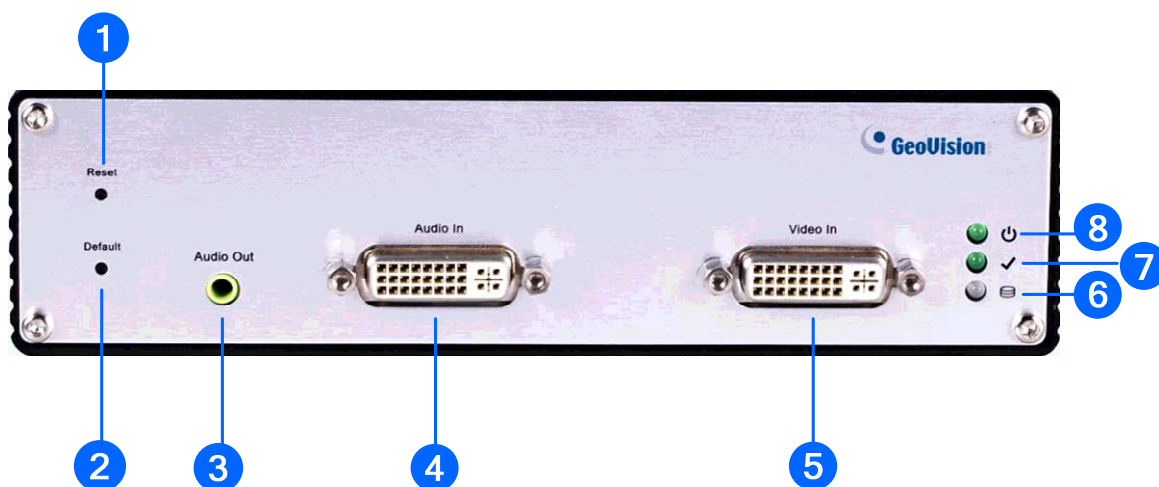

Figure 1-7

No.	Name	Function
1	Reset	It reboots the GV-Video Server, and keeps all current configurations.
2	Default Button	It resets all configurations to their factory settings. See 6.4 <i>Restoring to Factory Default Settings</i> .
3	Audio Out	A plug for the speaker device.
4	Audio In	A DVI plug connected with 16 RCA ports for audio inputs.
5	Video In	A DVI plug connected with 16 BNC ports for video inputs.
6	Disk Full/Fault LED	This LED is on, indicating the hard drive is full or faulty.
7	Ready LED	This LED is on, indicating the GV-Video Server is ready for connection.
8	Power LED	This LED is on, indicating the power is supplied.

Note: When transmitting video signals over a long distance, it is highly recommended to use 5C-FB coaxial cables or above to minimize the degradation of image quality. The transmission distance should be within 300 m (984 ft).

1.7.2 Rear View

1.7.2.1 GV-VS04H / 14

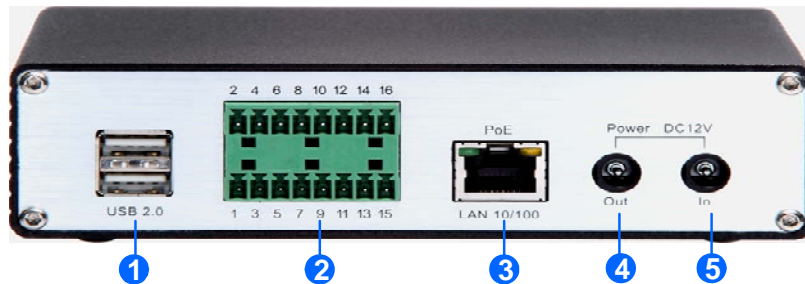

Figure 1-8

No.	Name	Function
1	USB Port	2 USB ports for installing portable storage devices.
2	Terminal Block	The connectors for digital inputs, relay outputs, PTZ cameras, Wiegand device and GPS module control. See <i>Chapter 9 Auxiliary Device Connectors</i> .
3	Ethernet Port	A plug for a 10/100 Ethernet or PoE. Note: GV-VS14 does not support PoE function.
4	Power Out	A plug to power the camera, by using a DC Male-to-Male Cable, directly through the GV-Video Server. Note: When PoE is applied, you cannot power the camera through the GV-Video Server.
5	Power In	A plug for power input.

1.7.2.2 GV-VS11

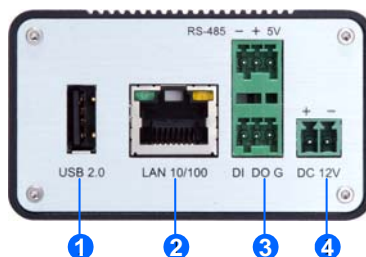

Figure 1-9

No.	Name	Function
1	USB Port	1 USB port for installing portable storage device.
2	Ethernet Port	A plug for inserting an Ethernet cable to build the network connection.
3	Terminal Block	The connectors for digital input, digital output and PTZ camera control. See <i>Chapter 9 Auxiliary Device Connectors</i> .
4	Power In	A plug for power input.

1.7.2.3 GV-VS12

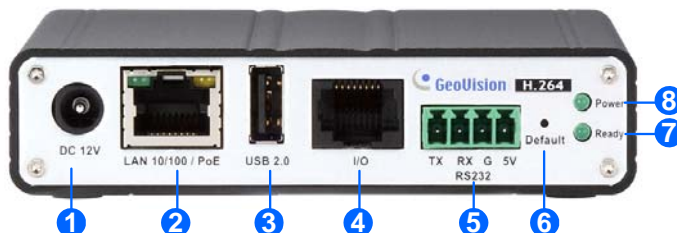

Figure 1-10

No.	Name	Function
1	Power In	A plug for power input.
2	Ethernet Port	A plug for a 10/100 Ethernet or PoE.
3	USB Port	1 USB port for installing the portable storage device.
4	I/O / PTZ Port	A port for digital input, relay output and PTZ camera control. Insert the I/O Cable with RJ-45 Connector to this port. See <i>Chapter 9 Auxiliary Device Connectors</i> .
5	RS-232 Terminal Block	The connectors for GPS module control. See <i>Chapter 9 Auxiliary Device Connectors</i> .
6	Default Button	It resets all configurations to their factory settings. See <i>6.4 Restoring to Factory Default Settings</i> .
7	Ready LED	This LED is on, indicating the GV-Video Server is ready for connection.
8	Power LED	This LED is on, indicating the power is supplied.

1.7.2.4 GV-VS2420 / 2400

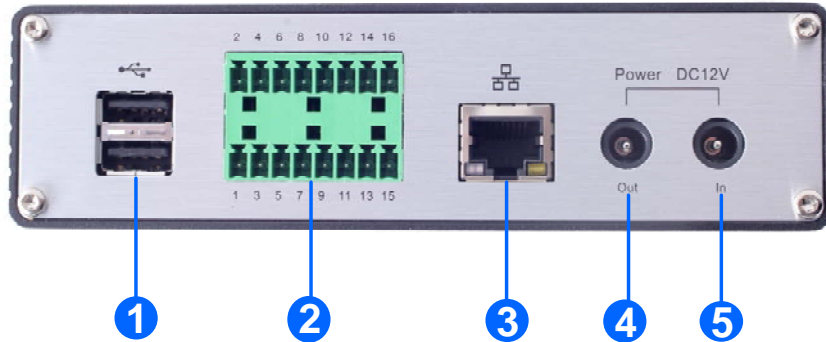

Figure 1-11

No.	Name	Function
1	USB Port	2 USB ports for installing portable storage devices.
2	Terminal Block	The connectors for digital inputs, digital outputs, and PTZ cameras. See <i>Chapter 9 Auxiliary Device Connectors</i> .
3	Gigabit Ethernet Port	A plug for a 10/100/1000 Base-T Ethernet
4	Power Out	A plug to power the camera, by using the optional DC Male-to-Male Cable, directly through the GV-Video Server
5	Power In	A plug for power input.

1.7.2.5 GV-VS2401

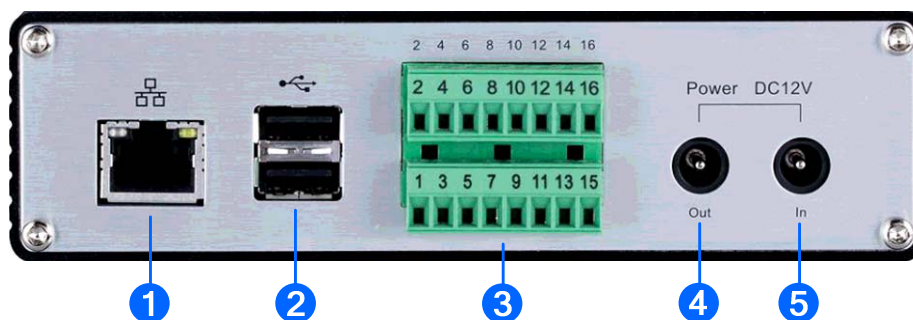

Figure 1-12

No.	Name	Function
1	Gigabit Ethernet Port	A plug for a 10/100/1000 Base-T Ethernet
2	USB Port	2 USB ports for installing portable storage devices.
3	Terminal Block	The connectors for digital inputs, digital outputs, and PTZ cameras. See <i>Chapter 9 Auxiliary Device Connectors</i> .
4	Power Out	A plug to power the camera, by using the optional DC Male-to-Male Cable, directly through the GV-Video Server
5	Power In	A plug for power input.

1.7.2.6 GV-VS2820 / 2800 / 21600

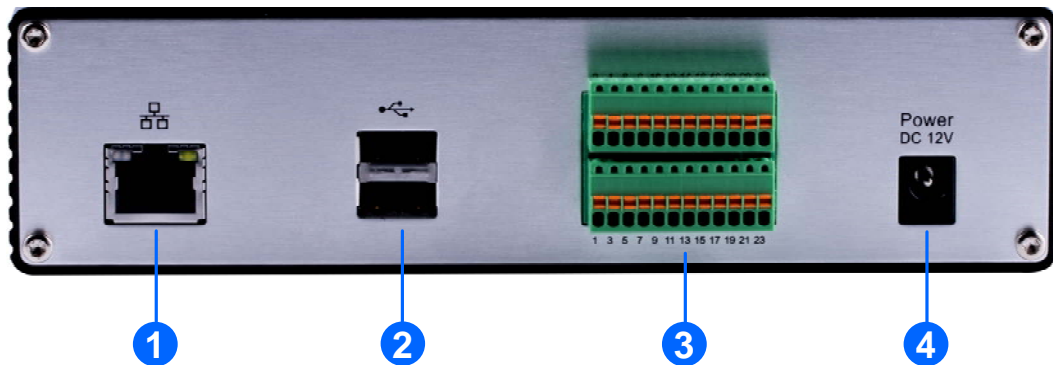

Figure 1-13

No.	Name	Function
1	Gigabit Ethernet Port	A plug for a 10/100/1000 Base-T Ethernet
2	USB Port	2 USB ports for installing portable storage devices.
3	Terminal Block	The connectors for digital inputs, digital outputs and PTZ cameras. See <i>Chapter 9 Auxiliary Device Connectors</i> .
4	Power In	A plug for power input.

Chapter 2 Getting Started

This section provides basic information to get the GV-Video Server working on the network.

2.1 Installing on a Network

These instructions describe the basic connections to install the GV-Video Server on the network. Here we use **GV-VS04H** as an example for demonstration.

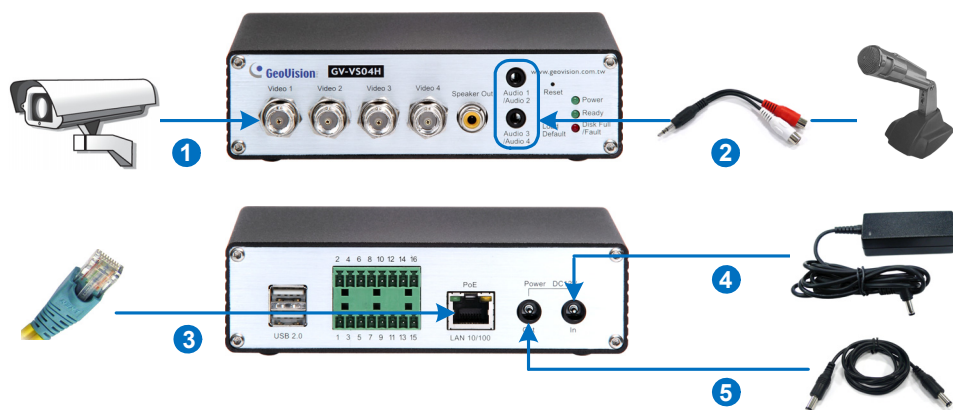

Figure 2-1

1. Connect your camera's video output to the BNC video input.
2. Connect the microphone to the RCA audio input using the 3.5 mm Stereo to RCA Cable.
3. Connect the hub or switch on the LAN to the unit's 10/100 Mbps port.
4. Connect the power using one of the following methods:
 - Use the supplied power adapter to connect to power.
 - Use the Power over Ethernet (PoE) function to provide power over the network cable.
5. Optionally connect the DC Male-to-Male Cable to power the camera through the GV-Video Server.
6. Wait until both Power and Ready LEDs are on.
7. By default, the GV-Video Server is assigned with an unused IP address by the DHCP server when the unit is connected to the network. The IP address remains unchanged unless you unplug or disconnect it from the network.
 - To see how to look up the IP address assigned by the DHCP server, see 2.2 *Checking the IP Address*.
 - If the GV-Video Server is installed in a LAN without the DHCP server, the default IP address 192.168.0.10 will be applied. To change the IP address, see 2.3 *Changing the IP Address*.

Note:

1. GV-VS11 / 14 / 2420 / 2400 / 2401 / 2820 / 2800 / 21600 do not support PoE function.
 2. For the users of other models, see the optional accessories in *1.6 Options*.
 3. GV-Video Server cannot work with microphones requiring power from the unit. Use the microphone that has external power supply.
 4. When PoE is applied, you cannot power the camera through the GV-Video Server.
-

2.2 Checking the IP Address

By default, an unused IP address is automatically assigned by the DHCP server to the GV-Video Server when connecting to the network. Follow the steps below to look up the IP address and access the Web interface.

1. Install the GV-IP Device Utility program from GeoVision download page:
<http://www.geovision.com.tw/download/product/>.

Note: The PC installed with GV-IP Device Utility must be under the same LAN as the GV-Video Server you wish to configure.

2. On the GV-IP Utility window, click the  button to search for the IP devices connected in the same LAN. Click the **Name** or **Mac Address** column to sort.

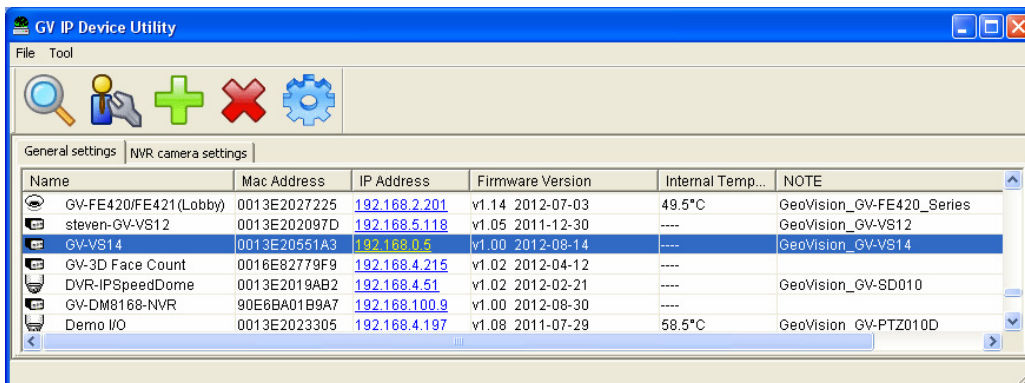

Figure 2-2

3. Find the GV-Video Server with its Mac Address to see the IP address.
4. To login, type the IP address in your Web browser. A dialog box appears.
5. Type the default username and password **admin**.
6. Click **Apply** to access the Web interface.

2.3 Changing the IP Address

To assign a static IP address or establish a connection to your ISP, log in the Web interface to access the network setting page.

Note: If your router does not support DHCP, the default IP address will be **192.168.0.10**. In this case, it is strongly suggested to modify the IP address to avoid IP address conflict with other GV-IP device on the same LAN.

1. Open your Web browser, and type the IP address of the GV-Video Server or the default IP address <http://192.168.0.10>.
2. In both Login and Password fields, type the default value **admin**. Click **Apply**.
3. In the left menu, select **Network** and select **LAN** to begin the network settings.

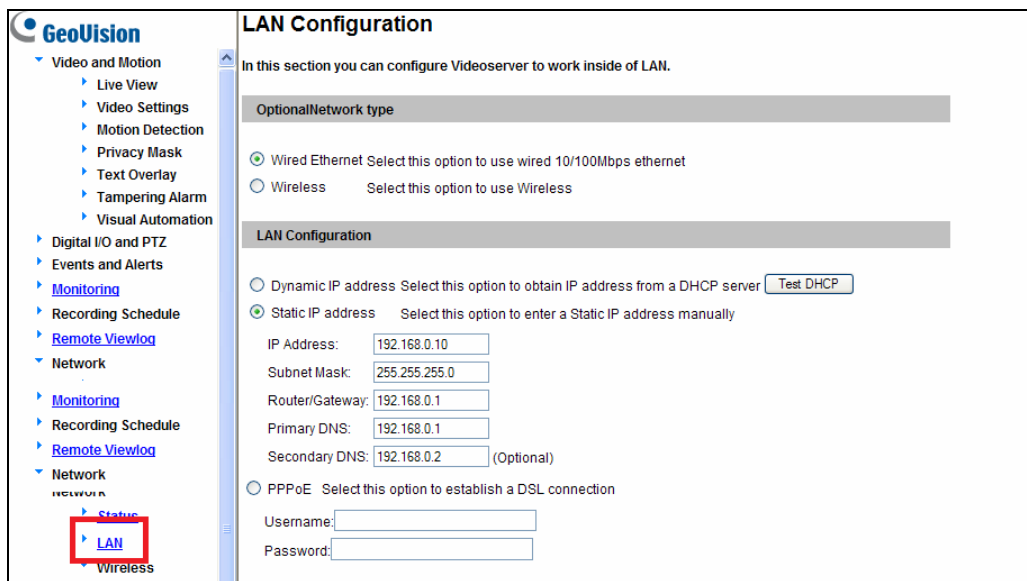

Figure 2-3

4. To assign a static IP address, select **Static IP address**. Type IP Address, Subnet Mask, Router/Gateway, Primary DNS and Secondary DNS.
5. To establish a connection to your ISP, select **Use PPPoE**, and type the username and password.
6. Click **Apply**. The GV-Video Server is accessible by entering the assigned IP address on the Web browser.

For details, see 4.7.1 LAN.

IMPORTANT:

- **PPPoE** should only be enabled if you know which IP address the GV-Video Server will get from the ISP. Otherwise, you must use the Dynamic DNS service to obtain a domain name linked to the GV-Video Server's changing IP address first.

For details on Dynamic DNS Server settings, see [4.7.3 Advanced TCP/IP](#).

- If **PPPoE** is enabled and you cannot access the unit, you may have to reset it to the factory default settings and then perform the network settings again.

To restore the factory settings, see the **Default** button in [1.7.1 Front View](#).

2.4 Configuring the Basics

Once the GV-Video Server is properly installed, refer to the following sections in this manual for some of the important features that can be configured using the browser-based configuration page:

- **Date and time adjustment:** see [4.8.1 Date and Time Settings](#).
- **Login and privileged passwords:** see [4.8.4 User Account](#).
- **Network gateway:** see [4.7 Network](#).
- **Camera image adjustment:** see [3.2.2 The Control Panel of the Live View Window](#).
- **Video format, resolution and frame rate:** see [4.1.2 Video Settings](#).

Chapter 3 Accessing the GV-Video Server

Two types of users are allowed to log in the GV-Video Server: **Administrator** and **Guest**. The Administrator has unrestricted access to all system configurations, while the Guest has the access to live images and network status only.

3.1 Accessing Your Surveillance Images

Once installed, your GV-Video Server is accessible on a network. Follow these steps to access your surveillance images:

1. Open a Web browser.
2. Enter the IP address or domain name of the GV-Video Server in the **Location/Address** field of your browser.

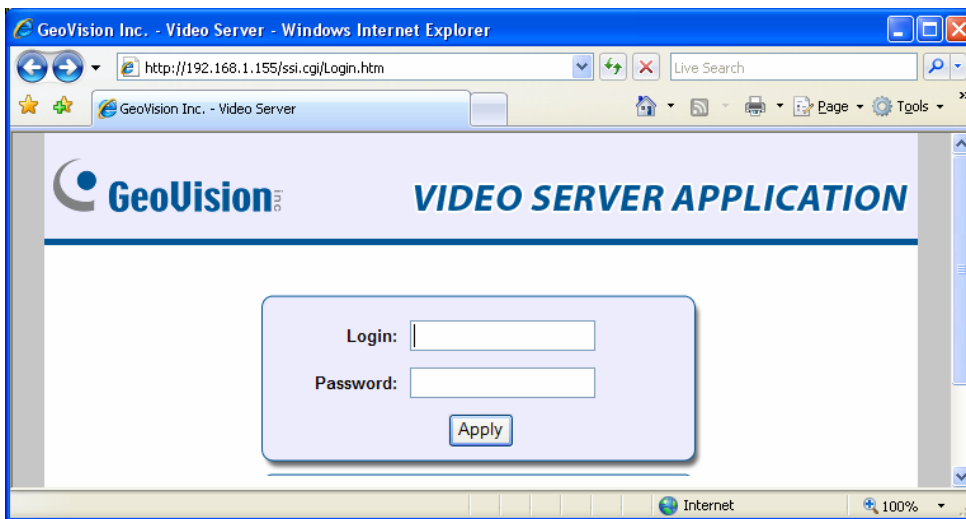

Figure 3-1

3. Enter the login name and password.
 - The default login name and password for Administrator are **admin**.
 - The default login name and password for Guest are **guest**.
4. The live view Web page is now displayed on your browser.
 - For Internet Explorer, a video image, similar to the example in Figure 3-2, is now displayed in your browser.
 - For Chrome, Safari, or Microsoft Edge, click **GV-Web Viewer**, type the IP address of your camera and click **Connect** to access the full functioning user interface.

Note: To enable the updating of images in Microsoft Internet Explorer, you must set your browser to allow ActiveX Controls and perform a one-time installation of GeoVision's ActiveX component onto your computer.

3.2 Functions Featured on the Main Page

This section introduces the features of the **Live View** window and **Network Status** on the main page. The two features are accessible by both Administrator and Guest.

Main Page of Guest Mode

- ▼ Video and Motion
 - ▼ Live View
 - ▶ Camera 1
 - ▶ Camera 2
 - ▶ Camera 3
 - ▶ Camera 4
 - ▶ 4 Cameras
- ▼ Network
 - ▶ Status

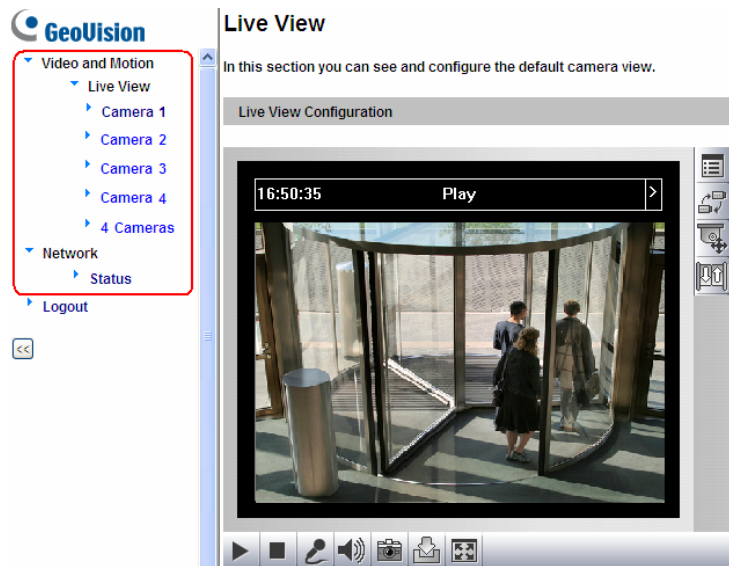

Figure 3-2 Main page of GV-VS04H in Guest Mode

For GV-VS11 / 14 / 2420 / 2400 / 2401 / 2820 / 2800 / 21600 users, you can process each video stream in two different image settings. In the Administrator mode, both streams are available. Click **Streaming 1** or **Streaming 2** in the left menu to access the live view. In the Guest mode, only one stream is available.

3.2.1 The Live View Window

In the left menu, click **Live View** and select the desired Camera to see live video.

Live View



Figure 3-3

No.	Name	Function
1	Play	Plays live video.
2	Stop	Stops playing video.
3	Microphone	Talks to the surveillance area from the local computer.
4	Speaker	Listens to the audio around the camera.
5	Snapshot	Takes a snapshot of live video. --- See 3.2.3 <i>Snapshot of a Live Video</i> .
6	File Save	Records live video to the local computer. --- See 3.2.4 <i>Video Recording</i> .
7	Full Screen	Switches to full screen view. Right-click the image to have these options: Snapshot , PIP , PAP , Zoom In and Zoom Out . --- See 3.2.5 <i>Picture-in-Picture and Picture-and-Picture View</i> .
8	I/O Control	Starts I/O Control Panel or Visual Automation. --- See 3.2.13 <i>I/O Control</i> .
9	PTZ Control	Starts PTZ Control Panel and Visual PTZ. --- See 3.2.11 <i>PTZ Control</i> and 3.2.12 <i>Visual PTZ</i> .

10	Change Camera	Sets the desired camera for display.
11	Show System Menu	Brings up these functions: Alarm Notify, Video and Audio Configuration, Remote Config, Show Camera Name and Image Enhance. --- See 3.2.6 Alarm Notification, 3.2.7 Video and Audio Configuration, 3.2.8 Remote Configuration, 3.2.9 Camera Name Display and 3.2.10 Image Enhancement respectively.

Note:

1. For GV-VS2420 / 2400, only Camera 1 supports audio function.
2. For some models with camera switch buttons above the Live View window, select the desired stream and camera from the listed tabs to access the live view.

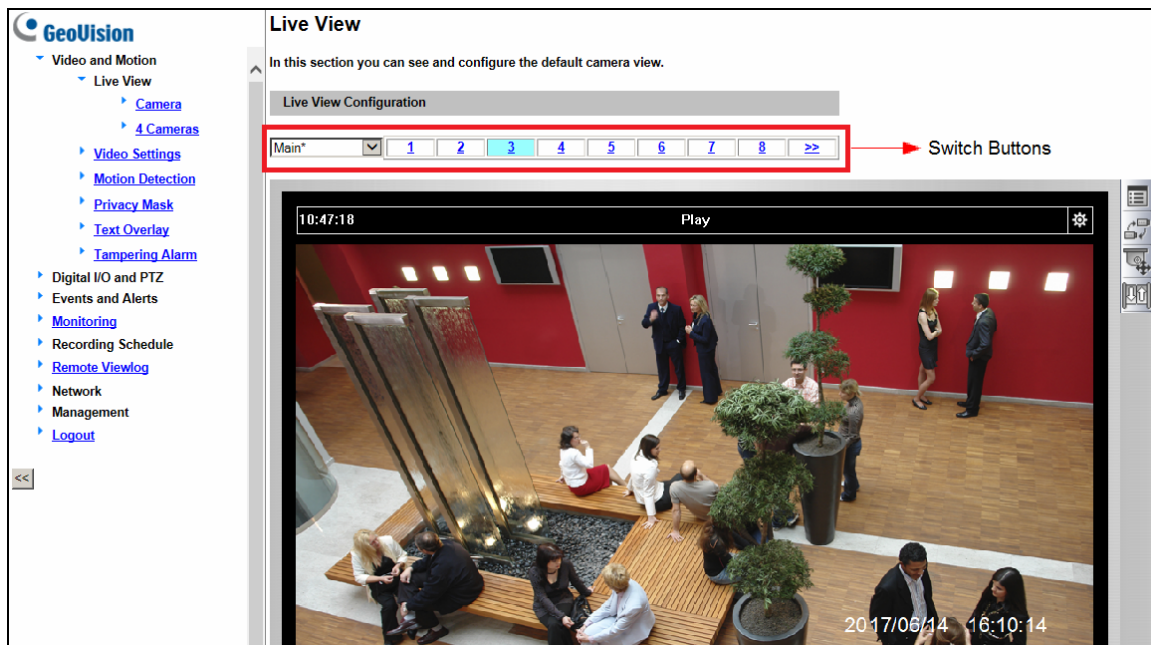



Figure 3-4

3.2.2 The Control Panel of the Live View Window

To open the control panel of the Live View window, click the arrow button or  on top of the viewer. You can access the following functions by using the right and left arrow buttons on the control panel.

Click the arrow button to display the control panel.

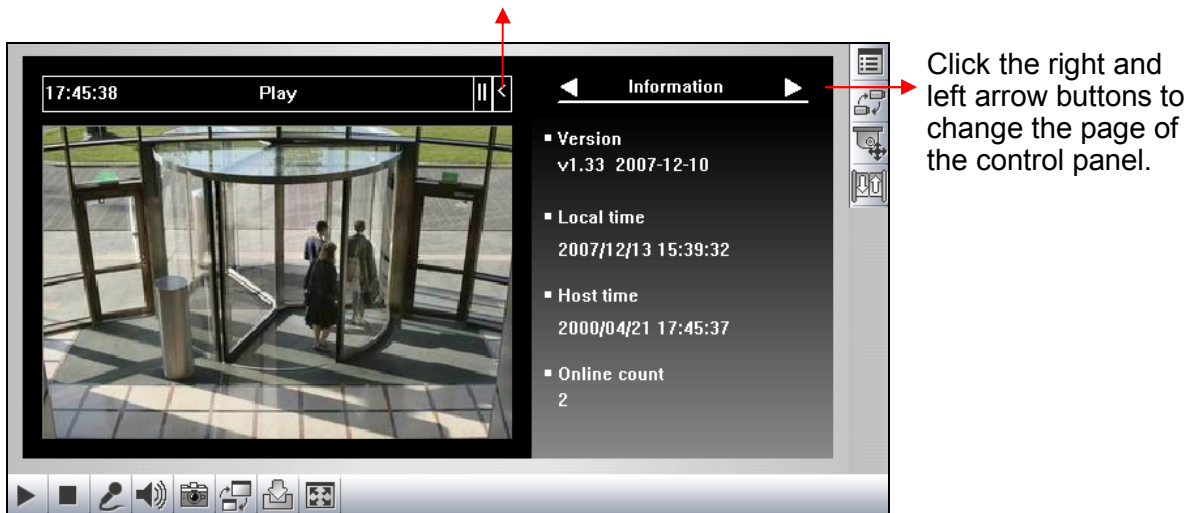

Figure 3-5

[Information] Displays the version of the Video Server, the time of the local computer, host time of the Video Server, the number of users logging in to the Video Server and the OCX registration path.

[Video] Displays the current video codec, resolution and data rate.

[Audio] Displays the audio data rates when the microphone and speaker devices are enabled. Note that for GV-VS2420 / 2400, only Camera 1 supports audio function.

[I/O Control] Provides a real-time graphic display of the input and output status. You can force the output to be triggered by double-clicking its icon.

[Alarm Notify] Displays the captured images by sensor triggers and/or motion detection. For this function to work, you must configure the Alarm Notify settings first. See 3.2.6 *Alarm Notification*.

[Camera Adjustment] Allows you to adjust the image quality.

[GPS] For details, see 6.3 *GPS Tracking*. This function is not supported by GV-VS11 and GV-VS2420 / 2400 / 2401 / 2820 / 2800 / 21600.

[Download] Allows you to install the OCX programs from the hard drive. This function is only supported by GV-VS04H / 11 / 12 / 14.

[Internal Temperature] Displays the current chipset temperature inside the camera. This function is only available for GV-VS2420 / 2400 / 2401 / 2820 / 2800 / 21600.

3.2.3 Snapshot of a Live Video

To take a snapshot of live video, follow these steps:

1. Click the **Snapshot** button (No. 5, Figure 3-3). The Save As dialog box appears.
2. Specify **Save in**, type the **File name** and select **JPEG** or **BMP** as **Save as Type**. You may also choose whether to display the name and date stamps on the image.
3. Click the **Save** button to save the image in the local computer.

3.2.4 Video Recording

Follow the steps below to record live video(s) to your local computer.

1. Click the **File Save** button (No. 6, Figure 3-3). The **Save As** dialog box appears.
2. Specify **Save in**, type the **File name** and move the **Time Period** scroll bar to specify the time length of each video clip(s) to be saved in, from 1 to 5 minutes.
3. Click the **Save** button to start recording.
4. To stop recording, click the **Stop** button (No. 2, Figure 3-3).

3.2.5 Picture-in-Picture and Picture-and-Picture View

The full screen mode provides two types of close-up views: **Picture-in-Picture (PIP)** and **Picture-and Picture (PAP)**. The two views are useful to provide clear and detailed images of the surveillance area.

To access this feature:

- Click the **Full Screen** button (No. 7, Figure 3-3). Right-click the full screen to have the options of **PIP** and **PAP**.
- Right-click the live view to have the options of **PIP** and **PAP**.

Picture-in-Picture View

With the Picture in Picture (PIP) view, you can crop the video to get a close-up view and zoom in on the video.



Figure 3-6

1. Select **PIP**. An inset window appears.
2. Click the inset window. A navigation box appears.
3. Move the navigation box around in the inset window to have a close-up view of the selected area.
4. To adjust the navigation box size, move the cursor to any of the box corners, and enlarge or diminish the box.
5. To change the frame color of the navigation box or hide the box, right-click the image, select **Mega Pixel Setting** and click one of these options:
 - **Set Color of Focus Area:** Changes the color of the box frames.
 - **Hide PIP Window:** Displays or hides the navigation boxes on the image.
6. To exit the PIP view, right-click the image and click **PIP** again.

Picture-and-Picture View

With the Picture and Picture (PAP) view, you can create a split video effect with multiple close-up views on the image. A total of 7 close-up views can be defined.



Figure 3-7

1. Select **PAP**. A row of three inset windows appears at the bottom.
2. Draw a navigation box on the image, and this selected area is immediately reflected in one inset window. Up to seven navigation boxes can be drawn on the image.
3. To adjust a navigation box size, move the cursor to any of the box corners, and enlarge or diminish the box.
4. To move a navigation box to another area on the image, drag it to that area.
5. To change the frame color of the navigation box or hide the box, right-click the image, select **Mega Pixel Setting** and click one of these options:
 - **Display Focus Area of PAP Mode:** Displays or hides the navigation boxes on the image.
 - **Set Color of Focus Area:** Changes the color of the box frames.
6. To delete a navigation box, right-click the desired box, select **Focus Area of PAP Mode** and click **Delete**.
7. To exit the PAP view, right-click the image and click **PAP** again.

3.2.6 Alarm Notification

Upon input trigger and motion detection events, you can be alerted by a pop-up live video and view up to four captured images.



Figure 3-8

To configure this function, click the **Show System Menu** button (No. 11, Figure 3-3), and select **Alarm Notify**. This dialog box appears.

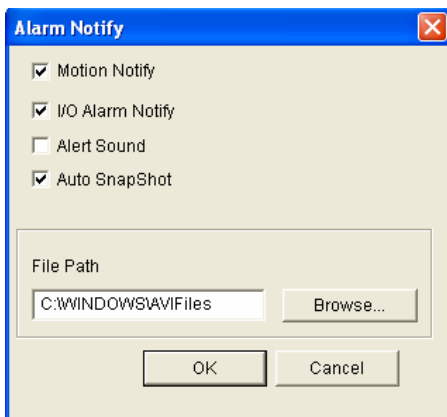

Figure 3-9

- **Motion Notify:** Once motion is detected, the captured images are displayed on the control panel of the Live View window.
- **I/O Alarm Notify:** Once the input device is triggered, the captured images are displayed on the control panel of the Live View window. For this function to work, the Administrator needs to install the input device properly. See *4.2.2 Input/Output Settings*.
- **Alert Sound:** Activates the computer alarm upon motion and input trigger detection.
- **Auto Snapshot:** The snapshot of live video is taken every 5 seconds upon motion and input trigger detection.
- **File Path:** Assigns a file path to save the snapshots.

3.2.7 Video and Audio Configuration

You can enable the microphone and speaker for two-way audio communication and adjust the audio volume. To change audio configuration, click the **Show System Menu** button (No. 11, Figure 3-3) and select **Video and Audio Configuration**.

Note:

1. GV-VS11 only supports one-way audio communication.
 2. For GV-VS2420 / 2400, only Camera 1 supports audio function.
-

- **Audio Configure:** Enables the microphone and speaker, and adjust the audio volume.
- **Camera:** Sets the number of frames to keep in live view buffer. Keeping more frames for live view buffer can ensure a smooth live view, but the live view will be delayed for the number of frames specified.

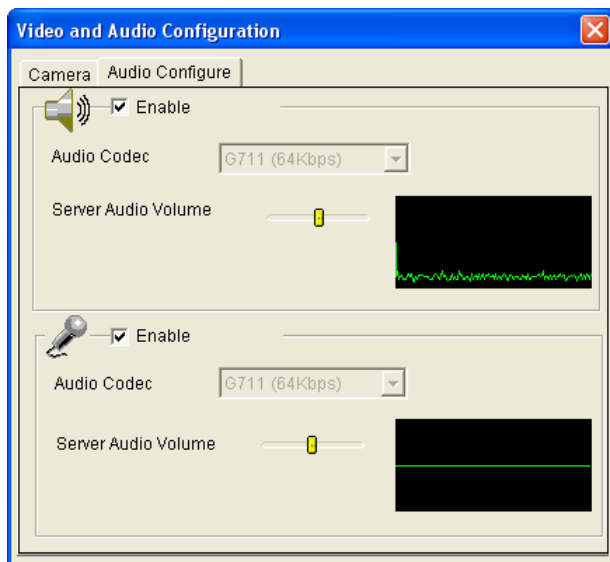

Figure 3-10

3.2.8 Remote Configuration

You can upgrade firmware over the Internet. Click the **Show System Menu** button (No. 11, Figure 3-3) and select **Remote Config**. The Remote Config dialog box will appear.

[Firmware Upgrade] In this tab, you can upgrade the firmware over the network. For details, see *Chapter 6 Advanced Applications*.

3.2.9 Camera Name Display

To display the camera name on the image, click the **Show System Menu** button (No. 11, Figure 3-3) and select **Show Camera Name**.

3.2.10 Image Enhancement

To enhance the image quality of live video, click the **Show System Menu** button (No. 11, Figure 3-3) and select **Image Enhance**. This dialog box appears.

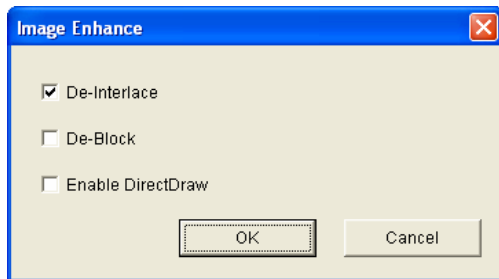

Figure 3-11

- **De-Interlace:** Converts the interlaced video into non-interlaced video.
- **De-Block:** Removes the block-like artifacts from low-quality and highly compressed video.
- **Enable DirectDraw:** Activates the DirectDraw function.

3.2.11 PTZ Control

To open the PTZ control panel, click the **PTZ Control** button (No. 9, Figure 3-3) and select **PTZ Control Panel**.

Note: Different PTZ devices have different functions, so the features included in the **Option** button may vary.

This feature is only available when the PTZ is predefined by the Administrator. For details, see 4.2.1 *PTZ Settings*.

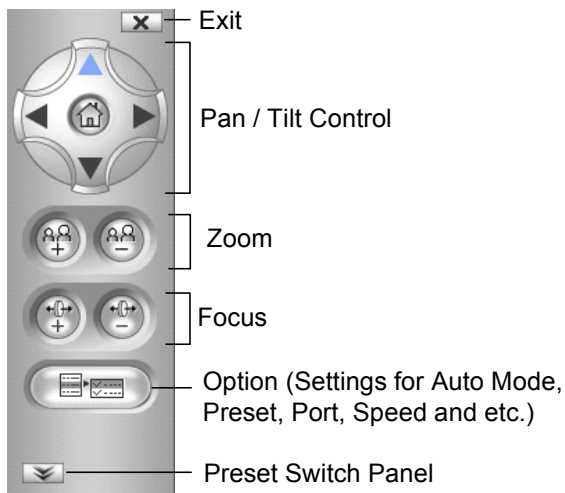

Figure 3-12

3.2.12 Visual PTZ

In addition to the PTZ control panel, you can display a **Visual PTZ** control panel on the image. This feature is only available when the PTZ is predefined by the Administrator. For details, see 4.2.1 PTZ Settings.



Figure 3-13

- To access this feature, click the **PTZ Control** button (No. 9, Figure 3-3) and select **Visual PTZ**.
- To change the panel settings, click the green **PTZ** button on the top left corner. You will have these options:

[PTZ Control Type]

- **Type 1:** In this mode when you place the mouse arrow on the four directions, i.e. north, south, east, west, the speed indicator of five levels will appear. Click and hold on the required level of movement and the camera will move as per the selected speed.
- **Type 2:** In this mode with the mouse click, the PTZ control panel will appear. The movement of the camera will depend on the speed of the mouse movement.

[Configure]

- **Set Color:** Changes the color of the panel. Three kinds of colors are available: **Red**, **Green** and **Blue**.
- **Transparent Degree:** Adjusts the transparency level of the panel. Ten levels range from 10% (fully transparent) to 100% (fully opaque).

3.2.13 I/O Control

The I/O Control window provides real-time graphic displays of camera, I/O status and alarm events. Additionally, you can force output to be triggered.

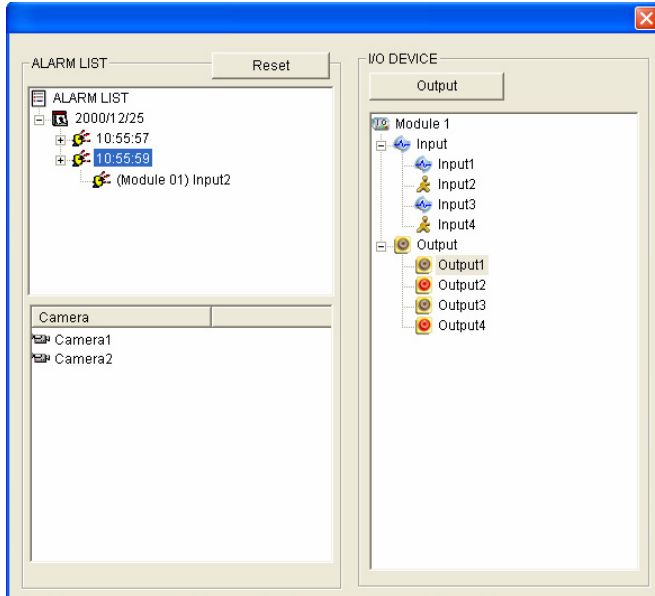

Figure 3-14

- To display the I/O control window, click the **I/O Control** button (No. 8, Figure 3-3).
- The Alarm List is displayed in three levels. The first level indicates date, the second indicates time, and the third indicates alarm ID. Click the **Reset** button to clear the list.
- To trigger an output device, highlight an output and click the **Output** button.

3.2.14 Visual Automation

The Visual Automation allows you to change the current state of the electronic device by simply clicking on its image, e.g. turning the light ON. This feature is only available when the Visual Automation is predefined by the Administrator. For details, see 4.1.7 *Visual Automation*.

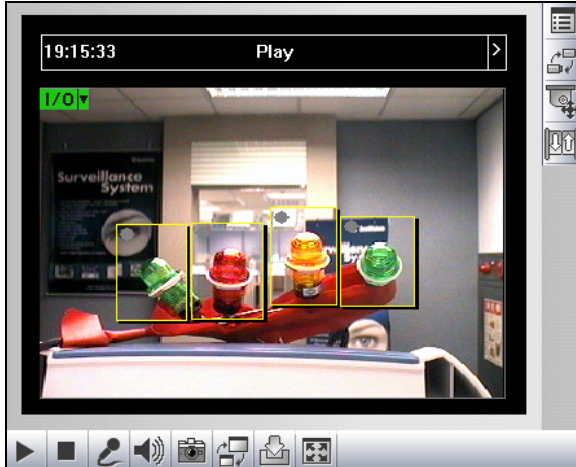

Figure 3-15

- To access this feature, click the **I/O Control** button (No. 8, Figure 3-3) and select **Visual Automation**.
- To change the style of the set areas, click the green **I/O** button on the top left corner. You will have these options:
 - **Show All:** Displays all set areas.
 - **Rect Float:** Embosses all set areas.
 - **Set Color:** Changes the frame color of all set areas

3.2.15 Network Status

To view the network status, click **Network** and select **Status** in the left menu.

Network Status Information	
In this section you can see an overview of videosever status.	
Current Status Information	
interface:	Wired
IP Acquirement:	Fixed
MAC Address:	0013E2023255
IP Address:	192.168.0.32
Subnet Mask:	255.255.248.0
Gateway:	192.168.0.1
Domain Name Server 1:	192.168.0.1
Domain Name Server 2:	192.168.0.2

Figure 3-16

Chapter 4 Administrator Mode

The Administrator can access the system configuration of GV-Video Server via the Internet. There are eight categories of the system configuration: **Video and Motion**, **Digital I/O and PTZ**, **Events and Alerts**, **Monitoring**, **Recording Schedule**, **Remote ViewLog**, **Network**, and **Management**.

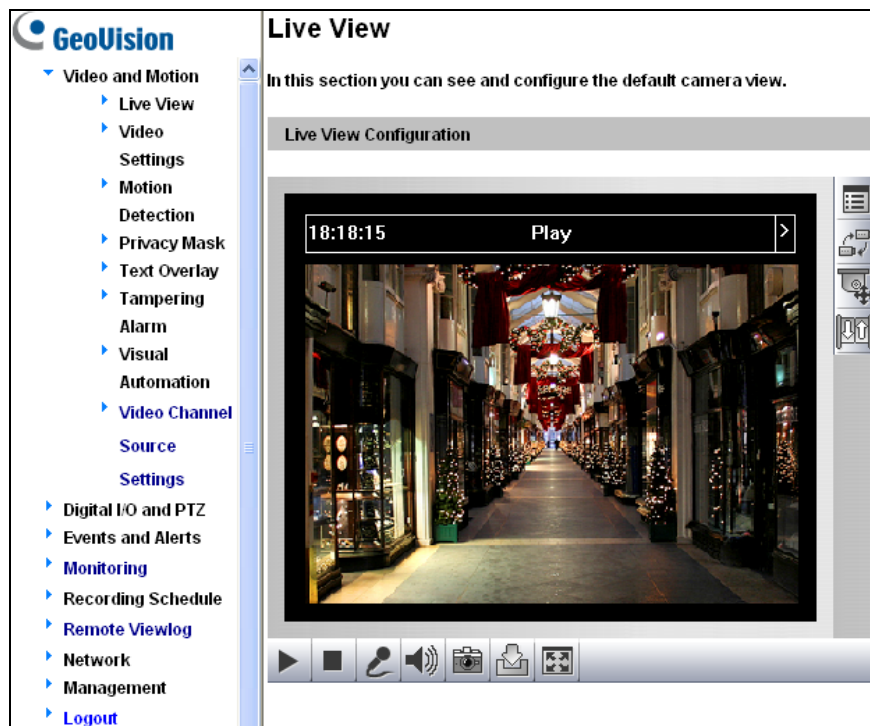

Figure 4-1

Note: For some models, you will see the following two different user interfaces. Use them properly to help manage your camera settings.

1. To access the live views or arrange the settings for individual cameras, select the desired stream and camera from the switch buttons at the top of the setting page.

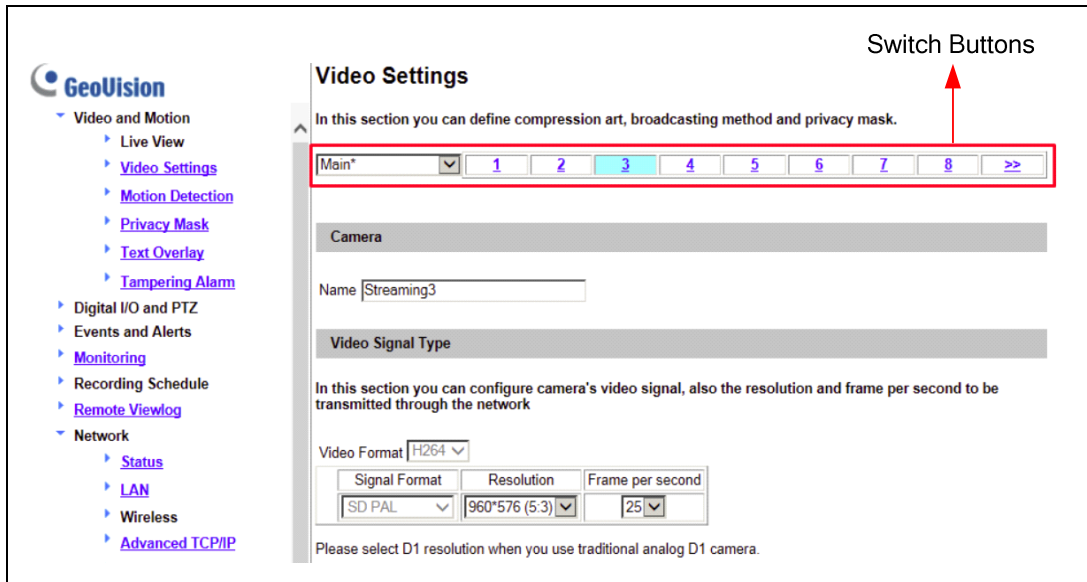

Figure 4-2

2. To manage specific input / output or camera setting functions, click the number buttons to make the selection or click **ALL** to configure a certain setting for all at once.

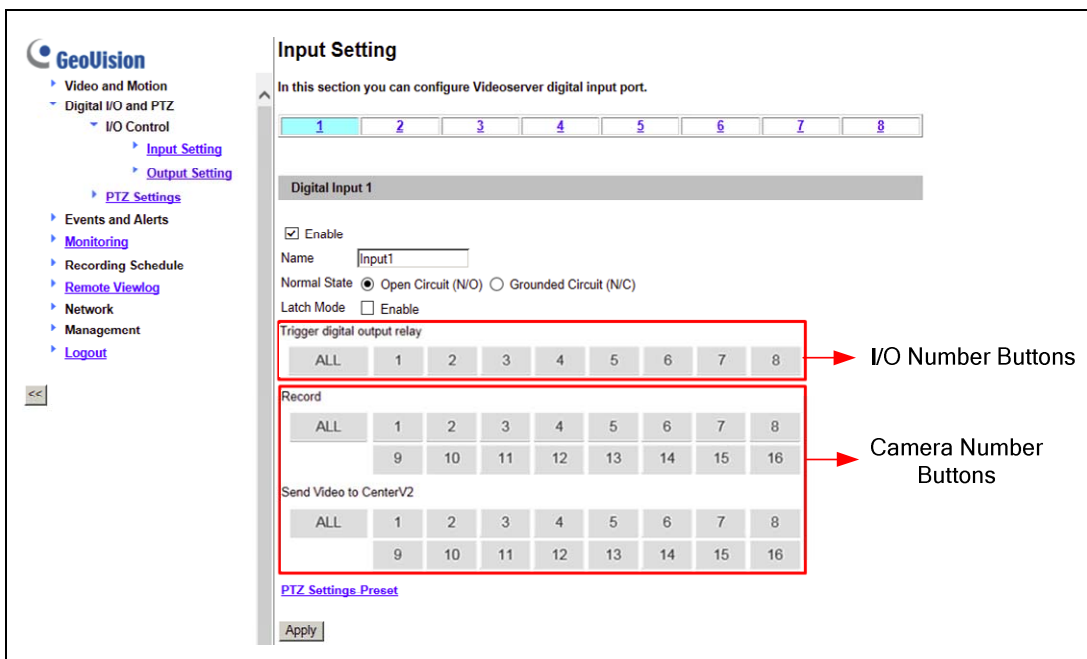

Figure 4-3

List of Menu Options

Find the topic of interest by referring to the section number prefixed to each option. The available options vary among different video server models.

4.1 Video and Motion	<ul style="list-style-type: none"> 4.1.1 Multicast 4.1.2 Video Settings 4.1.3 Motion Detection 4.1.4 Privacy Mask 4.1.5 Text Overlay 4.1.6 Tampering Alarm 4.1.7 Visual Automation 4.1.8 Video Channel Source Settings
4.2 Digital I/O and PTZ	<ul style="list-style-type: none"> 4.2.1 PTZ Settings 4.2.2 Input/Output Settings 4.2.3 GPS / Wiegand 4.2.4 Buzzer
4.3 Events and Alerts	<ul style="list-style-type: none"> 4.3.1 E-mail 4.3.2 FTP 4.3.3 Center V2 4.3.4 Vital Sign Monitor 4.3.5 GV-GIS 4.3.6 Backup Center 4.3.7 Video Gateway / Recording Server 4.3.8 ViewLog Server 4.3.9 3GPP / RTSP / ONVIF
4.4 Monitoring	
4.5 Recording Schedule	<ul style="list-style-type: none"> 4.5.1 Recording Schedule Settings 4.5.2 I/O Monitoring Settings
4.6 Remote ViewLog	
4.7 Network	<ul style="list-style-type: none"> 4.7.1 LAN 4.7.2 Wireless-Client Mode 4.7.3 Advanced TCP/IP 4.7.4 UMTS 4.7.5 Multicast 4.7.6 IP Filter 4.7.7 SNMP Setting
4.8 Management	<ul style="list-style-type: none"> 4.8.1 Date and Time Settings 4.8.2 GPS Maps Settings 4.8.3 Storage Settings 4.8.4 User Account 4.8.5 Log Information 4.8.6 System Log 4.8.7 Tools 4.8.8 Language

Comparison Table for Major Functions

The options or functions on the left menu of the Web interface (Figure 4-1) may vary depending on the models. The table below provides an overview of their major differences in supported functions.

Model Function	GV-VS04H (FW V1.03 or later)	GV-VS11 (FW V1.0 or later)	GV-VS12 (FW V1.02 or later)	GV-VS14 (FW V1.0 or later)	GV-VS2420 / 2400 / 2401 / 2820 / 2800 / 21600
Dual Streams	No	Yes	No	Yes	Yes
Wiegand	Yes	No	No	Yes	No
Buzzer	Yes	No	No	No	No
Multicast	Yes	Yes	Yes	Yes	No
Tampering Alarm	Yes	Yes	Yes	Yes	Yes
Watermark	Yes	Yes	Yes	Yes	Yes
Text Overlay	Yes	Yes	Yes	Yes	Yes
Video Channel Source Settings	Yes	No	No	No	No
System Log	Yes	Yes	Yes	Yes	No
GV-Backup Center Connection	Yes	Yes	Yes	Yes	Yes
GV-Video Gateway Connection	Yes	Yes	Yes	Yes	Yes
GV-GIS Connection	Yes	No	Yes	Yes	No

4.1 Video and Motion

This section includes the video image settings and introduces how the images can be managed using Multicast, Motion Detection, Privacy Mask, Tampering Alarm, Visual Automation and Video Channel Source Settings.

4.1.1 Multicast

Note this function is only available for **GV-VS04H** (Firmware Version 1.03 or later), **GV-VS11 / 12** (Firmware Version 1.05 or later) and **GV-VS14**.

The Multicast view allows the GV-Video Server to receive video and audio streams from a multicast group. It also enables the GV-Video Server to receive audio broadcast from the hosts in the multicast group.

To join a multicast group and listen to audio broadcasting, it is required to activate the related settings in *4.7.5 Multicast*.



Figure 4-4

1. The host(s), in the multicast group, is displayed automatically on the host list. If you cannot see any host displayed, click the **Configure** button, select **General Setup**, select **Multicast** and ensure the relevant IP address, port number and network card are correctly configured.
2. Expand the Host folder and drag the desired cameras to the screen for display. If the host has already set a password, you will be prompted to enter it at this step.

3. To receive audio broadcasting, first ensure a speaker is properly installed on the local computer. Then click the **Configure** button, select **General Setup**, select **Receive broadcast audio**, and ensure the broadcast IP address and port number are correctly configured.
4. To save the current settings of screen division and camera display for future use, click the **Configure** button, select **Video List Setup**, and select **Export**. You can also select **Import** to apply the pre-defined settings.

4.1.2 Video Settings

For GV-VS11 / 14 / 2420 / 2400 / 2401 / 2820 / 2800 / 21600, it can simultaneously process one video stream in two different codec and resolutions. The dual-stream design benefits for lower bandwidth environment, allowing Streaming 2 set with lower resolution and codec for live streaming, and Streaming 1 set with highest resolution and codec H.264 for best recording quality. Two setting pages **Streaming 1** and **Streaming 2** are provided for separate setup.

Video Settings

In this section you can define compression art, broadcasting method and privacy mask.

Name
Name

Connection template

Video Signal Type
In this section you can configure camera's video signal between NTSC or PAL, also the resolution and frame per second to be transmitted through the network

Auto detect signal type on booting

	Signal Format	Resolution	Frame per second
<input checked="" type="radio"/>	NTSC	<input type="text" value=""/>	<input type="text" value="30"/>
<input type="radio"/>	PAL	<input type="text" value="352*288"/>	<input type="text" value="25"/>

Bandwidth Management
In this section you can configure the bit rate used by H.264 video stream. Using VBR (Variable Bit Rate) is an intelligent method to compensate between image quality and bandwidth control. But if you want to provide consistently the same image quality at bandwidth cost, please set to CBR (Constant Bit Rate).

VBR Quality

CBR Maximal Bit Rate

GOP Structure and Length
In this section you can configure the composition of the H.264 video stream (GOP structure). By using I-Frame only will increase video quality dramatically but also the bandwidth.

Group of Picture(GOP) (1 indicates to generate I-VOP only and disable motion detection)
Size

RecordSettings
In this section you can configure pre-alarm and post-alarm settings.

Pre-alarm recording time seconds

Post-alarm recording time seconds with hard disk installed (1~30)

Split interval minutes

Record audio

Text OverlaySettings
In this section you can set up Text Overlay

Overlaid with camera name

Overlaid with date stamps

Overlaid with time stamps

Overlaid with the GPS speed km/h mile/h

Overlay with digital input description name Input 1 Input 2 Input 3 Input 4

Watermark Setting
In this section you can set Watermark function.

Enable

Apply All Settings
In this section you can apply the settings to all cameras

Apply the settings to all cameras

Figure 4-5

[Name]

Rename the camera. The camera name will appear on the Live View. To display the camera name, see 3.2.9 *Camera Name Display*.

[Connection Template]

Note this function is only supported by **GV-VS04H / 11 / 12 / 14**. Select the type of network connection. Unless you select **Customized**, this option will automatically bring up the recommended video resolution, frame rate, bandwidth and GOP size.

Due to the bandwidth limitation for mobile phone connections, only the video resolutions 352 x 240 (352 x 288) are supported. The higher resolution you select, the higher frame rate or better video quality you will get. But note that your mobile phone must support the video resolution you wish to select.

Connection templates for mobile phone connections:

3GPPv7, Msview V2 / V3, Ssview V3 and GView V2 Supported	
Resolution	Frame Rate
NTSC 352 x 240	5
PAL 352 x 288	5

[Video Signal Type]

- **Video Format:** Note this function is only available for **GV-VS11 / 12**. Select a codec for the video stream.
- **Auto detect signal type on booting:** Automatically detects the type of video input between NTSC or PAL. For **GV-VS04H / 11 / 12 / 14**, select to enable this function. For **GV-VS2420 / 2400 / 2401 / 2820 / 2800 / 21600**, this function is enabled by default.

The supported codecs vary from model to model.

Model	Codec
GV-VS04H	H.264
GV-VS11	H.264, MPEG4 , MJPEG (Streaming 1 and 2)
GV-VS12	H.264, MPEG4 , MJPEG
GV-VS14	H.264 (Streaming 1), MJPEG (Streaming 2)
GV-VS2420 / 2400 / 2401 / 2820 / 2800 / 21600	H.264 (Streaming 1 and 2)

The image resolution varies from model to model.

Models	NTSC		PAL	
GV-VS04H, GV-VS11 / 12 / 14	704 x 480		704 x 576	
	704 x 480 de-interlace		704 x 576 de-interlace	
	352 x 240		352 x 288	
	176 x 112		176 x 144	
	NTSC HD, TVI	NTSC SD	PAL HD, TVI	PAL SD
GV-VS2400	1920 x 1080	960 x 480	1920 x 1080	960 x 576
	1280 x 720	720 x 480	1280 x 720	720 x 576
	640 x 360	480 x 240	640 x 360	480 x 288
	448 x 252	360 x 240	448 x 252	360 x 288
	NTSC HD, Combo	NTSC SD	PAL HD, Combo	PAL SD
GV-VS2401	2560 x 1440	960 x 480	2560 x 1440	960 x 576
	2048 x 1536	720 x 480	2048 x 1536	720 x 576
	1920 x 1080	480 x 240	1920 x 1080	480 x 288
	1280 x 720	360 x 240	1280 x 720	360 x 288
	640 x 360		640 x 360	
	448 x 252		448 x 252	
	NTSC HD, AHD	NTSC SD	PAL HD, AHD	PAL SD
GV-VS2420	1920 x 1080	960 x 480	1920 x 1080	960 x 576
	1280 x 720	720 x 480	1280 x 720	720 x 576
	640 x 360	480 x 240	640 x 360	480 x 288
	448 x 252	360 x 240	448 x 252	360 x 288
	NTSC HD, TVI	NTSC SD	PAL HD, TVI	PAL SD
GV-VS2800	2560 x 1440	960 x 480	2560 x 1440	960 x 576
	2048 x 1536	720 x 480	2048 x 1536	720 x 576
	1920 x 1080	480 x 240	1920 x 1080	480 x 288
	1280 x 720	360 x 240	1280 x 720	360 x 288
	640 x 360		640 x 360	
	448 x 252		448 x 252	
	NTSC HD, AHD	NTSC SD	PAL HD, AHD	PAL SD
GV-VS2820	2560 x 1440	960 x 480	2560 x 1440	960 x 576
	2048 x 1536	720 x 480	2048 x 1536	720 x 576
	1920 x 1080	480 x 240	1920 x 1080	480 x 288
	1280 x 720	360 x 240	1280 x 720	360 x 288

	640 x 360		640 x 360	
	448 x 252		448 x 252	
	NTSC HD, Combo	NTSC SD	PAL HD, Combo	PAL SD
GV-VS21600	1920 x 1080	960 x 480	1920 x 1080	960 x 576
	1280 x 720	720 x 480	1280 x 720	720 x 576
	640 x 360	480 x 240	640 x 360	480 x 288
	448 x 252	360 x 240	448 x 252	360 x 288

The frame rate varies from model to model.

Models	Format	Frame Rate
GV-VS04H, GV-VS11 / 12 / 14	NTSC	1, 2, 3, 5, 7.5, 10, 15, 30
	PAL	1, 2.5, 5, 8, 12.5, 25
GV-VS2420 / 2400 / 2401/ 2820 / 2800 / 21600	NTSC	1 ~ 30
	PAL	1 ~ 25

Note:

1. The GV-VS11 / 14 and GV-VS2420 / 2400 / 2401 / 2820 / 2800 / 21600 support dual streams. By default, the dual streams are not enabled on GV-VS11 / 14, but enabled on GV-VS2420 / 2400 / 2401 / 2820 / 2800 / 21600.
 2. For GV-VS11, four resolution options and three codec types are available for both streaming 1 and 2.
 3. The frame rate and the performance may vary depending on the number of connections and data bitrates (different scenes).
-

[Bandwidth Management]

When using MPEG-4 or H.264, it is possible to control the bitrate, allowing bandwidth management.

- **VBR (Variable Bitrate):** The quality of the video stream is kept as constant as possible at the cost of a varying bitrate. The bandwidth is much more efficiently used in comparison to CBR.
 - Set the image quality to one of the 5 standards: **Poor, Fair, Good, Great** and **Excellent**.
 - For GV-VS04H / 11 / 12 / 14 / 2420 / 2400 / 2401, set the Maximal Bitrate to **1, 2, 4, 6, or 8** Mbit. For GV-VS2820 / 2800 / 21600, set the Maximal Bit Rate to **1, 2, 3, or 4** Mbit.
- **CBR (Constant Bitrate):** CBR is used to achieve a specific bitrate by varying the quality of the stream. The bitrates available for selection depend on the image resolution.

Model	Bitrates for selection
GV-VS04H	3072 kbps, 2048 kbps, 1536 kbps, 1024 kbps, 768 kbps, 512 kbps, 384 kbps, 256 kbps (3GPPV7), 128 kbps (3GPPV7), 64 kbps (3GPPV6), 52 kbps (3GPPV6)
GV-VS14	
GV-VS11	2048 kbps, 1536 kbps, 1024 kbps, 768 kbps, 512 kbps, 384 kbps, 256 kbps (3GPPV7), 128 kbps (3GPPV7), 64 kbps (3GPPV6), 52 kbps (3GPPV6)
GV-VS12	
GV-VS2420 / 2400 / 2401	8192 kbps, 6144 kbps, 4096 kbps, 2048 kbps, 1024 kbps, 512 kbps.
GV-VS2820 / 2800 / 21600	4096 kbps, 3072 kbps, 2048 kbps, 1024 kbps, 512 kbps.

[GOP Structure and Length]

Set the maximum number of seconds between every key frame. For GV-VS04H / 11 / 12 / 14, select **Customized** in the **Connection Template** section before setting the length of GOP structure. For GV-VS2420 / 2400 / 2401 / 2820 / 2800 / 21600, you can directly configure the settings here.

[Record Settings]

The record settings allow you to capture images before and/or after the motion or I/O event happens.

- **Pre-alarm recording time:** Activates video recording before an event occurs. Set the recording time to 1 or 2 seconds. The recording is saved in the buffer of the video server.
- **Post-alarm recording time:** Activates video recording onto the attached USB mass storage device after an event occurs. Set the recording time from 1 to 30 seconds.
- **Split Interval (Max. Video Clip):** Sets the maximum time length of each recorded file from 1 to 5 minutes.
- **Record Audio:** Activates audio recording when an event occurs.
- **Immediately close file:** Note this function is only supported by GV-VS04H / 11 / 12 / 14. Ends a recorded file once a motion or an I/O trigger stops. When the option is enabled, the time length of a recorded file is based on the duration of a motion or an I/O trigger instead of the time you set for Max. Video Clip above. Select this option to have short recorded files and have an easier access through mobile phones.

[Text Overlay Settings]

The text overlay settings allow you to overlay camera names, date, time, GPS speed or names of selected inputs on live and recorded videos.

- **Overlaid with camera name:** Includes camera names on live and recorded videos.
- **Overlaid with date stamps:** Includes date stamps on live and recorded videos.
- **Overlaid with time stamps:** Includes time stamps on live and recorded videos.
- **Overlaid with the GPS speed:** Includes the vehicle speed in live and recorded videos. Note this function is only available for **GV-VS04H** (Firmware Version 1.05 or later), **GV-VS12** (Firmware Version 1.05 or later) and **GV-VS14**.
- **Overlaid with digital input description name:** Includes the names of selected inputs on live and recorded videos.

[Watermark]

Enable this option to watermark all recordings. The watermark allows you to verify whether the video has been tampered with. See *6.5 Verifying Watermark*.

[Apply All Settings]

Apply the settings to all cameras: Applies the same settings to other cameras. Note this function is only supported by GV-VS04H / 11 / 12 / 14.

4.1.3 Motion Detection

Motion detection is used to generate an alarm whenever movement occurs in the video image. You can configure up to 8 areas with different sensitivity values for motion detection.

Motion Detection

In this section you can define different region(s) for motion detection.

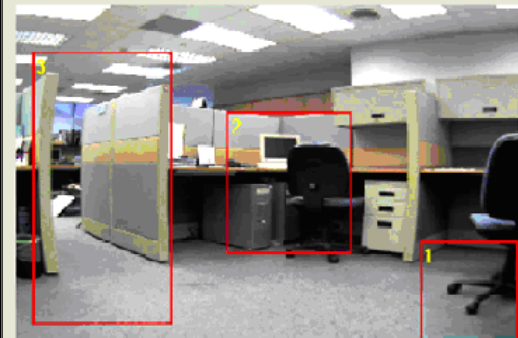

Camera
Camera1

Sensitivity: 2

Reset

Save

Please advise which action(s) should be taken when motion detection is activated.

Trigger digital output relay Output 1 Output 2

Center V2 server VSM Motion Detection Enable schedule mode

Apply

Select schedule time

Span 1 : ~ : Next Day

Span 2 : ~ : Next Day

Span 3 : ~ : Next Day

Weekend Saturday and Sunday Only Sunday

Apply

Figure 4-6

1. The default sensitivity value for the whole area is **2** for GV-VS04H and GV-VS11 / 12 / 14, and the value is **9** for GV-VS2420 / 2400 / 2401 / 2820 / 2800 / 21600. To define a different sensitivity value, click **Reset**.
2. Select the desired sensitivity by moving the slider to set the value. The higher the value, the more sensitive the camera is to motion.
3. Drag an area on the image. Click **Add** when you are prompted to confirm the setting.
4. To create several areas with different sensitivity values, repeat Steps 2 and 3.
5. Click **Apply** to save the above settings.

6. To trigger the alarm outputs when motion is detected, select the outputs (Output 1 to Output 4). To activate the output settings, you must also start **Camera** monitoring manually or by schedule. For related settings, see *4.4 Monitoring*.
7. To send motion detection notifications to Center V2 and Vital Sign Monitor during a particular time period, enable the schedule mode and click **Apply**.
 - A. Set the desired time frame(s) in a day. Each day can be divided into 3 time frames, represented by Span 1 to Span 3.
 - B. Enable the **Weekend** option to have whole-day monitoring on the weekend. Define whether your weekend includes **Saturday and Sunday** or **Only Sunday**.
 - C. Click **Apply** to save the above settings.

Note this function is only supported by GV-VS04H / 11 / 12 / 14.

Note: For **GV-VS11 / 12** users, this function does not work when MJPEG codec is selected in the Video Signal Type field (Figure 4-1). For details, see *4.1.2 Video Settings*.

8. If you want to ignore environmental changes such as rain or snow, select **Ignore environmental changes**. Note this function is only available for GV-VS2420 / 2400 / 2401 / 2820 / 2800 / 21600.
9. The **Noise Tolerance** function is enabled by default. It ignores video noise when the light intensity changes. Note this function is only available for GV-VS2420 / 2400 / 2401 / 2820 / 2800 / 21600.

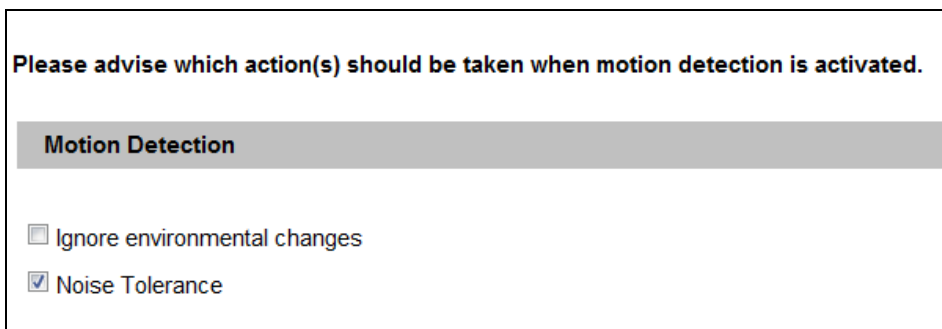

Please advise which action(s) should be taken when motion detection is activated.

Motion Detection

Ignore environmental changes

Noise Tolerance

Figure 4-7

4.1.4 Privacy Mask

The Privacy Mask can block out sensitive areas from view, covering the areas with dark boxes in both live view and recorded clips. This feature is ideal for locations with displays, keyboard sequences (e.g. passwords), and for anywhere else you don't want sensitive information visible.



Figure 4-8

1. Select the **Enable** option.
2. Drag the area(s) where you want to block out on the image. Click **Add** when you are prompted to confirm the setting.
3. Click the **Save** button to save all the settings.

4.1.5 Text Overlay

Note this option is only available for **GV-VS04H** (Firmware Version 1.03 or later), **GV-VS11 / 12** (Firmware Version 1.02 or later) and **GV-VS14 / 2420 / 2400 / 2401 / 2820 / 2800 / 21600**.

The Text Overlay function allows you to type any text in any place on the camera view. Up to 16 text messages can be created. The overlaid text will also be saved in the recorded images.

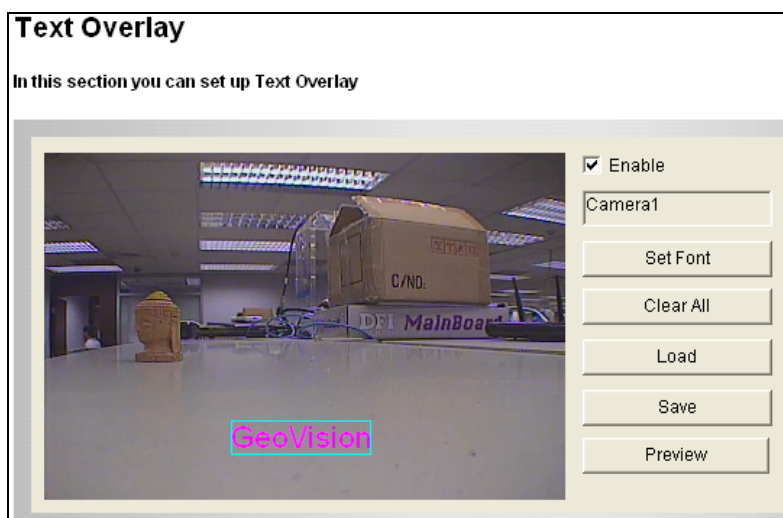

Figure 4-9

1. Select the **Enable** option.
2. Click any place on the image. This dialog box appears.

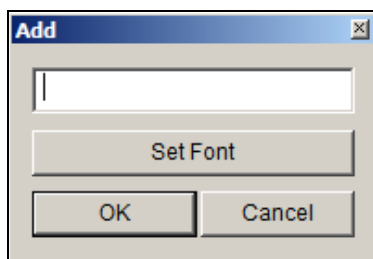

Figure 4-10

3. Type the desired text, and click **OK**. The text is overlaid on the image.
4. Click on the text and drag it to any place on the image.
5. Click **Set Font** to modify the font style of the text.
6. Click **Save** to apply the settings, click **Preview** to preview the camera view with overlaid text or click **Load** (Undo) to revert to the previous setting.

4.1.6 Tampering Alarm

Note this option is only available for **GV-VS04H** (Firmware Version 1.03 or later), **GV-VS11 / 12** (Firmware Version 1.02 or later) and **GV-VS14 / 2420 / 2400 / 2401 / 2820 / 2800 / 21600**.

The Tampering Alarm is used to detect when a camera is being physically tampered with. An alarm can be generated when the camera is moved, covered up, or out of focus. The alarm activation includes output device trigger, e-mail alerts and system buzzer. To have the tampering alarm, first set up the following:

- To trigger the output device when a tamper event occurs, enable the output setting and select **Tampering Alarm** for the related camera. See *Output Setting* in 4.2.2 *Input/Output Settings*.
- To trigger the e-mail alert when a tamper event occurs, enable the e-mail setting and select **Tampering Alarm** for the related camera. See 4.3.1 *E-Mail*.
- To trigger the system buzzer when a tamper event occurs, enable the buzzer setting. See 4.2.4 *Buzzer*.

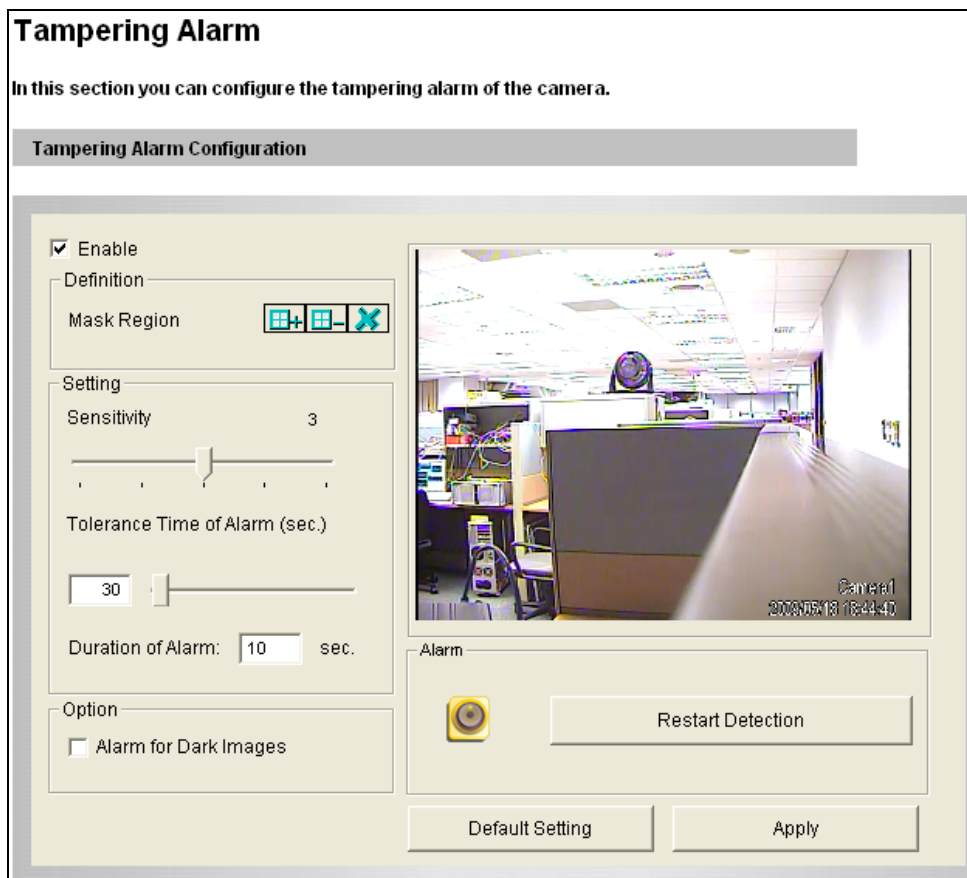



Figure 4-11

To configure the tampering alarm:

1. Select the **Enable** option.
2. If you want GV-Video Server to ignore any movement or scene change in certain areas, click the  button to drag areas on the camera view.
3. Select the desired detection sensitivity by moving the slider. The higher the value, the more sensitive the camera is to scene changes.
4. In the **Tolerance Time of Alarm** field, specify the time length allowed for scene changes before an alarm is generated.
5. In the **Duration of Alarm** field, specify the duration in which the alarm is triggered for before turning off.
6. To trigger an alarm when the scene turns dark, e.g. the lens of camera has been covered, select **Alarm for Dark Images**.
7. Click **Apply** to save all the settings.
8. Start monitoring to enable the function. To have buzzer alarm, it is required to start the **Camera** monitoring. To have output alarm, it is required to start **Input** monitoring. For these two types of monitoring, see *4.4 Monitoring*.

When the camera is tampered with, the output device and system buzzer can be activated. To turn off the output device and system buzzer immediately, return to this setting page, and click **Restart Detection**.

Note: The system buzzer is only supported by GV-VS04H (Firmware Version 1.03 or later).

4.1.7 Visual Automation

Note this option is only available for **GV-VS04H / 11 / 12 / 14 / 2400 / 2420**.

This intuitive feature helps you automate any electronic device by triggering the connected output device. You can change the current state of the connected device by clicking on its image, e.g. light ON.

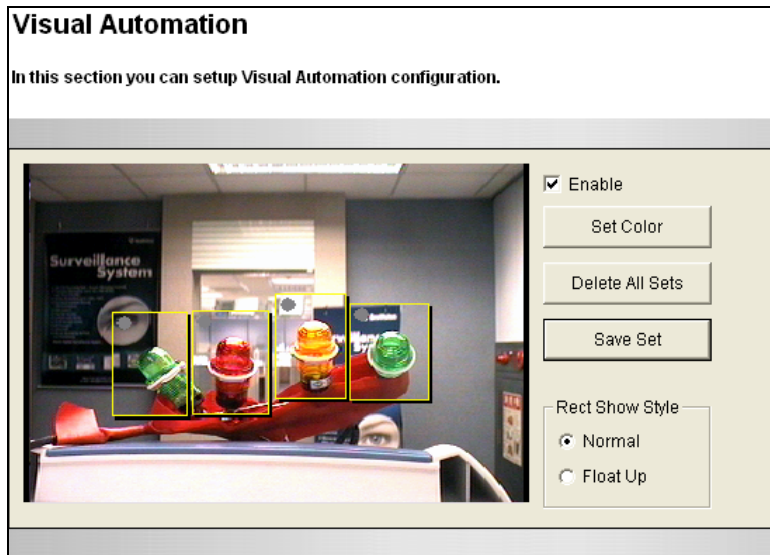

Figure 4-12

1. Select the **Enable** option.
2. Drag an area on the image of the electronic device. This dialog box appears.

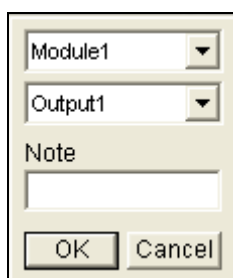

Figure 4-13

3. Assign the connected module and output device. In the Note field, type a note to help you manage the device. Click **OK** to save the settings.
4. To change the frame color of the set area, click the **Set Color** button.
5. To emboss the set area, select **Float Up**; or keep it flat by selecting **Normal**.
6. Click the **Save Set** button to apply the settings.

To perform the function, see 3.2.14 *Visual Automation*.

4.1.8 Video Channel Source Settings

Note this option is only available for **GV-VS04H** (Firmware Version 1.03 or later).

The function allows you to assign the video input to the desired video channel for display.

Video Channel Source Settings

In this section you can assign a video input source to each channel. By default, the video input source of each channel is based on hardware connection.

Video Channel Source Settings

Enable swapping video sources

Video channel 1	Video input source 1 ▼
Video channel 2	Video input source 2 ▼
Video channel 3	Video input source 3 ▼
Video channel 4	Video input source 4 ▼

Figure 4-14

4.2. Digital I/O & PTZ

For auxiliary device control, you can find one I/O / PTZ port along with one RS-232 terminal block for GPS control on the rear panel of **GV-VS12** (see Figure 1-8). On the rear panels of **GV-VS04H / 11 / 14 / 2420 / 2400 / 2401 / 2820 / 2800 / 21600**, all the functions for auxiliary device control are included in a terminal block. For details, see *Chapter 9 Auxiliary Device Connectors*.

The connectors for all terminal blocks on all models and the I/O / PTZ port on the GV-VS12 can be divided into four categories based on the interface being used:

1. Digital Input / Output
2. RS-485 interface or coaxial connection for PTZ control
3. Wiegand interface for access control
(only available on V-VS04H and GV-VS14)
4. GPS interface for vehicle tracking:
 - UART: available on GV-VS04H and GV-VS14
 - RS-232: available on GV-VS12

4.2.1 PTZ Settings

You can connect up to 4 PTZ cameras to your GV-VS2420 / 2400 / 2401 video server, up to 8 PTZ cameras to your GV-VS2820 / 2800, and up to 16 PTZ cameras to your GV-VS21600 video server through RS-485 interface on the I/O terminal block. In addition, you can also connect your GV-VS2420 / 2400 / 2401 / 2800 / 21600 directly through coaxial cables.

Note:

1. GV-VS2420 / 2400 / 2401 / 2820 / 2800 / 21600 supports the PTZ cameras with HD-TVI / AHD standard or RS-485 connection.
 2. GV-VS2820 does not support coaxial cable connections with PTZ cameras.
-

To configure PTZ settings:

1. Select the **Enable** Option.
2. Select a model name or a protocol from the PTZ Name drop-down list according to your camera models.
 - For the PTZ camera adopting HD-TVI / AHD standard, select **HD-TVI / AHD Coaxial** for coaxial cable transmission.
 - For the PTZ camera using RS-485 connection, select one of the others that corresponds to your PTZ camera.
3. Only for RS-485 connection, select a value corresponding to your PTZ camera from the Baud Rate and PTZ Address drop-down lists.
4. Click **Save** to save the above settings.

[Coaxial Settings]

- **Camera 1-16:** The number of cameras the GV-Video Server can connect to vary from model to model. Only for GV-VS2420 / 2400 / 2401 / 2800 / 21600 connected with HD-TVI / AHD camera, select the type of PTZ camera from the Camera drop-down list to enable coaxial cable transmission. For this specific model, DS-2AE5223TA-A of Hikvision, select **HIKVISION**. For other models of Hikvision or other cameras, **Generic** is selected by default.

PTZ Settings

In this section you can configure the integration with a PTZ Dome.

Camera(1) | Camera(2) | Camera(3) | Camera(4)

Enable

PTZ Name:

Baud Rate:

PTZ Address:

Coaxial Setting

Camera 1	<input type="text" value="Generic"/>	<input type="text" value="None"/>
Camera 2	<input type="text" value="HIKVISION"/>	<input type="text" value="DS-2AE5223TI-A"/>
Camera 3	<input type="text" value="Generic"/>	<input type="text" value="None"/>
Camera 4	<input type="text" value="Generic"/>	<input type="text" value="None"/>

Figure 4-15

Note:

1. Currently the GV-Video Server doesn't support the PTZ camera with RS-232 interface. For compatible PTZ models, see *Appendix E*.
2. It is highly recommended to use 5C-FB coaxial cables or above to minimize the degradation of image quality. The transmission distance should be within 300 m (984 ft). The 5C-FB coaxial cable connection is only supported by GV-VS2420 / 2400 / 2401 / 2800 / 21600.

4.2.2 Input/Output Settings

The number of input and output devices the GV-Video Server can connect to vary from model to model. The GV-VS04H / 14 / 2420 / 2400 / 2401 can connect up to 4 input and 4 output devices, GV-VS11 can connect 1 input and 1 output device, GV-VS12 can connect up to 2 input and 2 output devices, and GV-VS2820 / 2800 / 21600 can connect up to 8 input and output devices.

Input Setting

Input Setting

In this section you can configure videosever digital input port (4 sets).

Digital Input 1

Enable

Name

Normal State Open Circuit (N/O) Grounded Circuit (N/C)

Latch Mode Enable

Trigger digital output relay Output 1 Output 2 Output 3 Output 4

Record Camera 1 Camera 2

Send Video to CenterV2 Camera 1 Camera 2

PTZ Settings Set PTZ camera to preset point

Input on

Input off

Duration to set preset after input off seconds

Figure 4-16

- **Normal State:** Set up the input state to trigger actions by selecting Open Circuit (N/O) or Grounded Circuit (N/C).
- **Latch Mode:** Enable the mode to have a momentary output alarm.
- **Trigger Digital Output Relay:** Select the output(s) to be triggered once the input is activated.
- **Record:** Select the camera(s) to start recording once the input is activated.
- **Send Video to Center V2:** Select the camera(s) to send their images to Center V2 when the input is triggered.

You can direct a PTZ camera to a preset point upon input trigger:

- **Set PTZ camera to preset point:** Enable the preset function and select the PTZ camera.
- **Input on:** Direct the PTZ camera to a preset point when the input is triggered.
- **Input off:** Direct the PTZ camera to another preset point when the triggered input is off.
- **Duration to set preset after input off x seconds:** Specify the amount of time the PTZ camera stays in “Input on” preset point before moving to “Input off” preset point after the triggered input is turned off.

For related PTZ settings, see *4.2.1 PTZ Settings*.

Output Setting

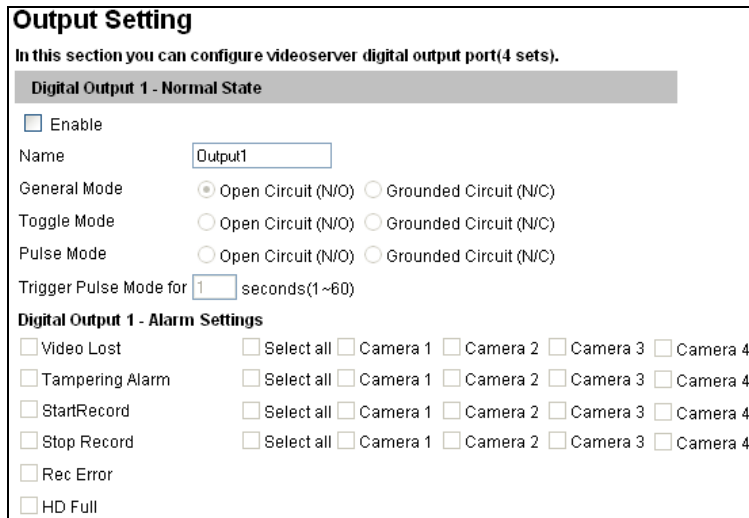

Figure 4-17

Select **Enable** to enable the output device. Choose the output signal that mostly suits the device you are using: N/O (Open Circuit), N/C (Grounded Circuit), N/O Toggle, N/C Toggle, N/O Pulse or N/C Pulse. For **Toggle** output type, the output will keep going on once it is triggered until the next trigger. For **Pulse** output type, the output is triggered for the amount of time you specify in the Trigger Pulse Mode for x Seconds field.

■ Alarm Settings:

You can choose to automatically activate the configured output device for alarm under these conditions: video lost, tampering alarm, video recording start (Start Record), video recording stop (Stop Record), disk write error (Rec Error) and hard disk full (HD Full).

Note the video recording start / stop function is only supported by GV-VS04H / 11 / 12 / 14.

Important: The input/output settings only function after you start **I/O Monitor** manually or by schedule. To configure the I/O monitoring, see [4.4 Monitoring](#).

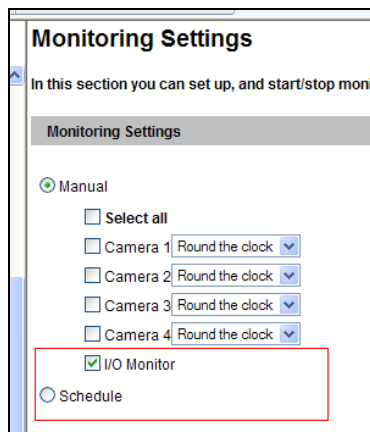

Figure 4-18

4.2.3 GPS/Wiegand

You can select either GPS or Wiegand function for use. The two functions cannot be enabled at the same time.

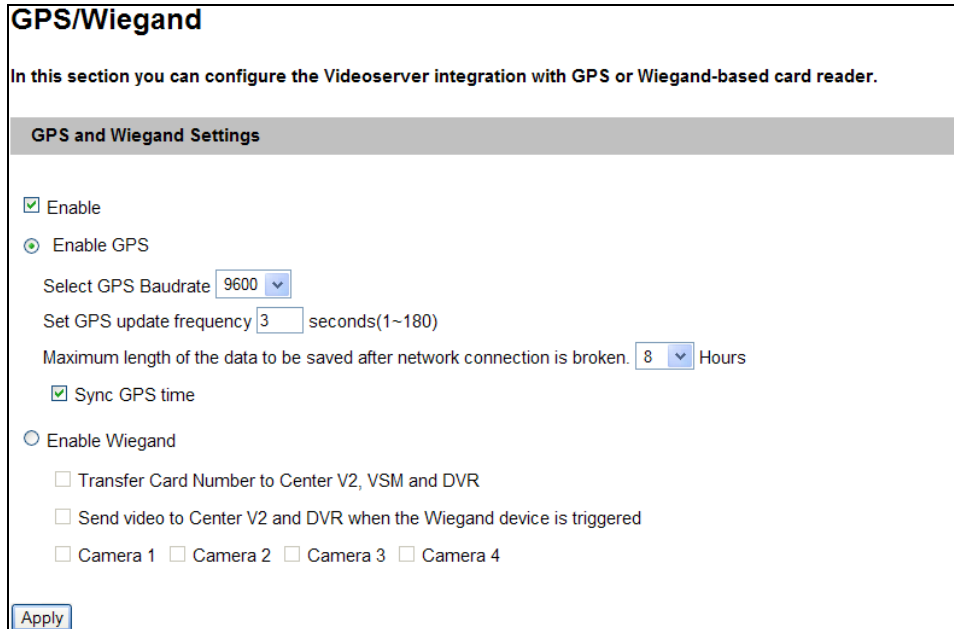

Figure 4-19

GPS Function

Note this function is only available for **GV-VS04H**, **GV-VS12** and **GV-VS14**.

The GV-Video Server supports the Global Position System (GPS) for active vehicle tracking and location verification. You can track the vehicle location on Google maps and display the average speed of a vehicle in live view.

To enable the GPS function, a GV-GPS Receiver or any GPS module supporting UART or RS-232 interface is required to connect to the GV-Video Server first. See *Chapter 9 Auxiliary Device Connectors*.

To enable the GPS function:

- **Select GPS Baud rate:** Two baud rate options are available: 4800 and 9600. The default value is 9600.
- **Set GPS Update Frequency:** Set the update frequency in seconds for GPS data.
- **Maximum length of the data to be saved after network connection is broken:** Specify the duration of GPS data to be saved in the storage device of GV-Video Server in case that the connection between GV-Video Server and GV-GIS is interrupted.

When the connection is resumed, the saved GPS data will be automatically sent to the GV-GIS and removed from the storage device. For the setup of GV-GIS connection, see 4.3.5 GV-GIS. Note this function is only available for **GV-VS04H** (Firmware V1.03 or later), **GV-VS12** (Firmware Version 1.04 or later) and **GV-VS14**.

- **Sync GPS Time:** Synchronizes the time of GV-Video Server with the GPS time once GV-Video Server receives GPS signals.

To display the vehicle speed:

Select **Overlaid with the GPS speed** on the Video Settings page, and click **Apply**.

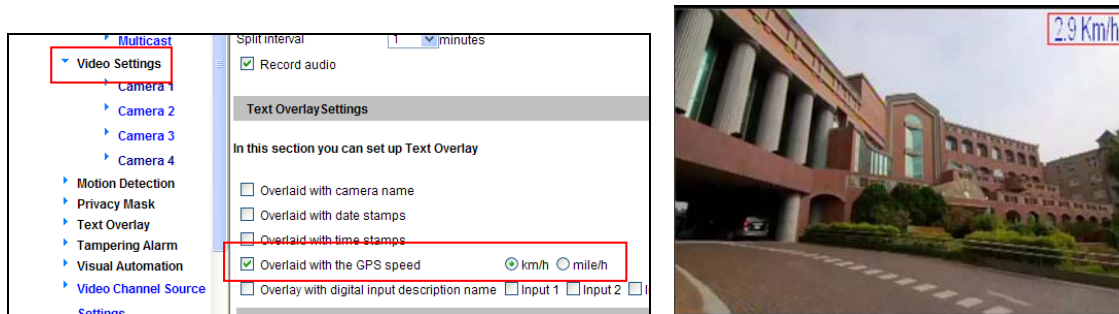

Video Settings page

Vehicle speed in live view

Figure 4-20

To track the vehicle location:

See 6.3 GPS Tracking.

To play back GPS tracks:

If the monitoring is also activated, the GPS tracks will be recorded along with video. This makes it possible to play back video with GPS tracks on maps using the Remote ViewLog player. See 5.2.3 Playback of GPS Tracks.

Wiegand Function

Note this function is only available for **GV-VS04H** and **GV-VS14**.

The GV-Video Server can work in conjunction with the Wiegand-interface card reader to send video and cardholder data to the central monitoring stations Center V2 and Vital Sign Monitor, as well as GV-DVR / NVR. Moreover, the Wiegand port on the GV-Video Server can be used as an input to activate recording once the card reader is triggered or a valid card is presented to the card reader.

The output format of Wiegand supported by the GV-Video Server is HID standard 26 bits and 37 bits.

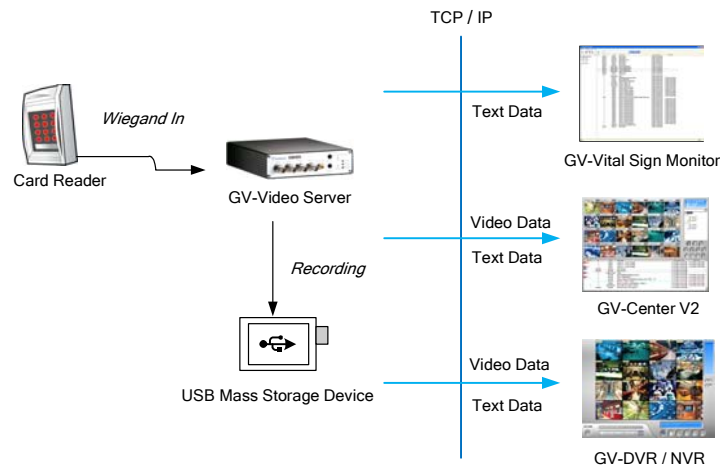

Figure 4-21

- Transfer Card Number to Center V2, Vital Sign Monitor and GV-DVR / NVR:** Sends the cardholder data to Center V2, Vital Sign Monitor and GV-DVR / NVR once the card reader is triggered.
- Send video to Center V2 and GV- DVR / NVR when the Wiegand device is triggered:** The selected camera(s) will start recording on the GV-Video Server and the related video will also be sent to Center V2 and GV-DVR / NVR once the card reader is triggered.

Note: To receive cardholder data from the GV-Video Server, the GV-DVR / NVR must be version 8.2 or later.

For the related settings, see [4.3.3 Center V2](#), [4.3.4 Vital Sign Monitor](#) and [7.3 Receiving Cardholder Data from Video Server](#).

4.2.4 Buzzer

Note this function is only available for **GV-VS04H** (Firmware Version 1.03 or later).

The system buzzer can be activated automatically under these conditions: video lost, input device triggered, motion detected, disk full, disk write error and tampering alarm. You can set the duration of buzzing sounds to be **5 Seconds**, **10 Seconds**, **20 Seconds** or **30 Seconds**. To turn on the buzzer, select **On**; to turn off the buzzer, select **Off**.

It is required to start monitoring for the buzzer to work. To start monitoring, see [4.4 Monitoring](#).

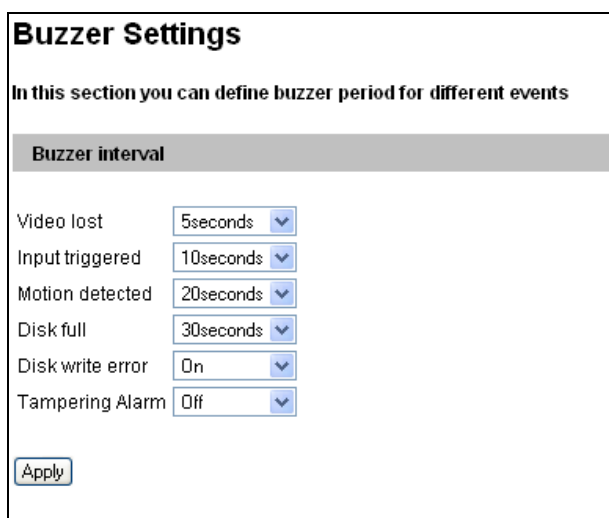

The screenshot shows a web interface titled "Buzzer Settings". Below the title is a subtitle: "In this section you can define buzzer period for different events". A section header "Buzzer interval" is followed by a list of events and their corresponding buzzer intervals, each with a dropdown menu:

Event	Buzzer Interval
Video lost	5seconds
Input triggered	10seconds
Motion detected	20seconds
Disk full	30seconds
Disk write error	On
Tampering Alarm	Off

At the bottom left of the settings area is an "Apply" button.

Figure 4-22

4.3 Events & Alerts

For the events of motion detection or I/O trigger, the Administrator can set up the two trigger actions:

1. Send a captured snapshot by e-mail or FTP.
2. Notify Center Monitoring Station, Center V2, Vital Sign Monitor or GV-GIS, by video or text alerts.

To have the above trigger actions, you must also set the following features:

- Motion Detection (See *4.1.3 Motion Detection*)---optional
- Input Setting (See *4.2.2 Input/Output Settings*)
- For e-mail and FTP alerts, it is required to start monitoring (See *4.4 Monitoring*).

Note: The Motion Detection function is an optional setting since it is activated by default.

4.3.1 E-mail

After a trigger event, the GV-Video Server can send the e-mail to a remote user containing a captured snapshot.

Figure 4-23

[Enable] Select to enable the e-mail function.

- **Sever URL/IP Address:** Type the SMTP Server's URL address or IP address.
- **Server Port:** Type the SMTP Server's port number. Or keep the default value 25.
- **From email address:** Type the sender's e-mail address.
- **Send to:** Type the e-mail address(s) you want to send alerts to.
- **Alerts Interval Time:** Specify the interval between e-mail alerts. The interval can be between 0 and 60 minutes. Any event trigger during the interval period will be ignored. This option is useful for the events with high occurrence.

[Need authentication to login] If the SMTP Server needs authentication, select this option and type the valid username and password.

[This server requires a secure connection] If the SMTP Servers needs a secure connection (SSL), select this option.

[Alarm Settings] You can choose to automatically send e-mail alerts under these conditions: video lost, tampering alarm, disk write error (Rec Error), hard disk full (HD full), motion detection and triggered input.

For the alarm condition **Motion Detection** and **Digital Input** triggered, a snapshot from the specified camera will be sent with the e-mail alert.

Note:

1. For GV-VS12, the **This server requires a secure connection** option is only available on Firmware Version 1.02 or later.
 2. The **Motion Detection** and **Digital Input** options (under the Alarm Settings section) are only available for GV-VS04H (Firmware Version 1.03 or later), GV-VS11 / VS12 (Firmware Version 1.04 or later) and GV-VS14 / 2420 / 2400 / 2401 / 2820 / 2800 / 21600.
-

For the related settings to send e-mail alerts, see *4.1.3 Motion Detection*, *4.2.2 Input/Output Settings* and *4.4 Monitoring*.

4.3.2 FTP

You can also send the captured snapshot to a remote FTP server for alerts.

FTP Client and Server Setting

In this section you can configure a ftp server (File Transfer Protocol) to handle events, videos, and error messages.

Upload to a FTP server

Enable

Server URL/IP Address

Server Port

User Name

Password

Remote Directory

Alerts Interval time in minute (0 to 60)

FTP - Alarm Settings

Motion Detection Select all Camera 1 Camera 2 Camera 3 Camera 4

Continuously send images upon trigger events(Motion)

Digital Input Select all

Input1

Input2

Input3

Input4

Continuously send images upon trigger events(Input)

Act as FTP server

In this section you can enable/disable videosever internal ftp server for file transfer.

Enable ftp access to the videosever

Use alternative Port

Figure 4-24

[Upload to a FTP Server]

- **Enable:** Select to enable the FTP function.
- **Server URL/IP Address:** Type the URL address or IP address of the FTP Server.
- **Port Number:** Type the port number of the FTP Server. Or keep the default value 21.
- **User Name:** Type a valid user name to log into the FTP Server.
- **Password:** Type a valid password to log into the FTP Server.
- **Remote Directory:** Type the name of the storage folder on the FTP Server.
- **Alerts Interval time in minute:** Specify the interval between each FTP alert. The interval can be between 0 and 60 minutes. Any event trigger during the interval period will be ignored. The option is useful for the events with high occurrence.

[Alarm Settings]

- **Motion Detection:** Once the motion is detected on the selected camera, a snapshot will be sent to the FTP Server as a notification.
 - ⊙ **Continuously send images upon trigger events (motion):** A sequence of snapshot images are uploaded to the FTP Server when motion is detected on the selected camera.
- **Digital Input:** Once the selected input is triggered, a snapshot from the specified camera will be sent to the FTP Server as a notification.
 - ⊙ **Continuously send images upon trigger events (input):** A sequence of snapshot images from the specified cameras are uploaded to the FTP Server when the selected input is triggered.

[Act as FTP Server]

- **Enable FTP access to the video server:** The GV-Video Server acts as a FTP server, enabling users to download AVI files.
- **Use alternative port:** The default port is set to 21.

To access the internal FTP server through a Web browser, enter the IP address or the domain name of the GV-Video Server in your browser like this:

ftp://192.168.0.10

When you are prompted for Username and Password, enter the default value **videoserver** in both fields. Then you should find the AVI files recorded after trigger events.

To change the login information of the internal FTP server, see *4.8.4 User Account*. For the related settings to send FTP alerts, see *4.1.3 Motion Detection*, *4.2.2 Input/Output Settings* and *4.4 Monitoring*.

4.3.3 Center V2

Upon motion detection or I/O trigger events, the central monitoring station Center V2 can be notified by live videos and text alerts. Up to two Center V2 servers can be connected simultaneously. For live monitoring through Center V2, you must already have a subscriber account on each Center V2 server.

Note: To receive video alerts upon input triggers, the software version of Center V2 must be 8.2 or later. Otherwise, the Center V2 will only have text alerts upon input triggers.

Connection 1
Connection 2

Center V2

In this section you can configure the connection to Center V2 and tasks to perform.

Center V2 server

Activate Link

Host name or IP Address:

Port number:

User Name:

Password:

Cease motion detection messages from Select all Camera 1 Camera 2 Camera 3 Camera 4

Cease input trigger message from Select all Input 1 Input 2 Input 3 Input 4

Cease video lost messages from Select all Camera 1 Camera 2 Camera 3 Camera 4

Enable schedule mode

Select schedule time

Span 1 : ~ : Next Day

Span 2 : ~ : Next Day

Span 3 : ~ : Next Day

Weekend Saturday and Sunday Only Sunday

Connection Status

Status: Disconnected

Figure 4-25

To enable the Center V2 connection:

1. **Activate Link:** Enable the monitoring through Center V2.
2. **Host Name or IP Address:** Type the host name or IP address of Center V2.
3. **Port Number:** Match the port to **Port 2** on Center V2. Or keep the default value 5551. For details, see *8.1 Center V2*.
4. **User Name:** Type a valid user name to log into Center V2.
5. **Password:** Type a valid password to log into Center V2.
6. Click **Apply**. The Connection Status should display “Connected” and the connected time.
7. To establish the connection to the second Center V2 server, click the **Connection 2** tab and repeat the above steps for setup.

You can also find these options on this Center V2 setting page:

- **Cease motion detection messages from:** Stops notifying Center V2 of motion detection from the selected camera.
- **Cease input trigger messages from:** Stops notifying Center V2 of input trigger from the selected input.
- **Cease video lost messages from:** Stops notifying Center V2 of video lost from the selected camera.
- **Enable schedule mode:** Starts the monitoring through Center V2 based on the schedule you set in the **Select Schedule Time** section. Refer to *4.5 Recording Schedule* for the same settings.

For related settings to activate the monitoring through Center V2, see *4.1.3 Motion Detection*, *4.2.2 Input/Output Setting*, and *8.1 Center V2*.

4.3.4 Vital Sign Monitor

Upon motion detection or I/O triggered events, the central monitoring station Vital Sign Monitor can be notified by text alerts. Up to two Vital Sign Monitor servers can be connected simultaneously. For live monitoring through Vital Sign Monitor, you must already have a subscriber account on each Vital Sign Monitor server.

Connection 1 | Connection 2

Vital Sign Monitor Server Setting

In this section you can configure the connection to VSM Server and tasks to perform.

Vital Sign Monitor Server

Activate Link

Host name or IP Address:

Port number:

User Name:

Password:

Cease motion detection messages from Select all Camera 1 Camera 2 Camera 3 Camera 4

Cease input trigger message from Select all Input 1 Input 2 Input 3 Input 4

Cease video lost messages from Select all Camera 1 Camera 2 Camera 3 Camera 4

Enable schedule mode

Apply

Select schedule time

Span 1 : : ~ : **Next Day**

Span 2 : : ~ : **Next Day**

Span 3 : : ~ : **Next Day**

Weekend Saturday and Sunday Only Sunday

Apply

Connection Status

Status: Disconnected

Figure 4-26

To enable the Vital Sign Monitor connection:

1. **Activate Link:** Enable the monitoring through Vital Sign Monitor.
2. **Host Name or IP Address:** Type the host name or IP address of Vital Sign Monitor.
3. **Port Number:** Match the port to **Port 2** on Vital Sign Monitor. Or keep the default value 5609. For details, see *8.1 Center V2*.
4. **User Name:** Type a valid user name to log into Vital Sign Monitor.
5. **Password:** Type a valid password to log into Vital Sign Monitor.
6. Click **Apply**. The Connection Status should display “Connected” and the connected time.

7. To establish the connection to the second Vital Sign Monitor server, click the **Connection 2** tab and repeat the above steps for setup.

You can also find these options on this Vital Sign Monitor setting page:

- **Cease motion detection messages from:** Stops notifying Vital Sign Monitor of motion detection from the selected camera.
- **Cease input trigger messages from:** Stops notifying Vital Sign Monitor of input trigger from the selected input.
- **Cease video lost messages from:** Stops notifying Vital Sign Monitor of video lost from the selected camera.
- **Enable schedule mode:** Starts the monitoring through Vital Sign Monitor based on the schedule you set in the **Select Schedule Time** section. Refer to *4.5 Recording Schedule* for the same settings.

For related settings to activate the monitoring through Vital Sign Monitor, see *4.1.3 Motion Detection*, *4.2.2 Input/Output Settings*, and *8.2 Vital Sign Monitor*.

4.3.5 GV-GIS

Note the GV-GIS with two connections is only available on **GV-VS04H** (Firmware Version 1.03 or later), **GV-VS12** (Firmware Version 1.02 or later) and **GV-VS14**.

Through the Internet connection, the GV-Video Server with enabled-GPS function can send GPS data and live video to the GV-GIS geographic information system for the services of vehicle tracking, location verification and live monitoring. The GV-Video Server can connect up to two GV-GIS systems simultaneously.

Before you configure the GV-GIS connection on this setting page, the following conditions must be met:

- A subscriber account created on the GV-GIS (For details on the GV-GIS geographic information system, see *GV-GIS User's Manual*)
- UMTS mobile connection activated on the GV-Video Server (See 4.7.4 UMTS)
- GPS function activated on the GV-Video Server (See 4.2.3 GPS/Wiegand)

Connection 1
Connection 2

GV-GIS

In this section you can configure the connection to GV-GIS and tasks to perform.

GV-GIS Server

Activate Link

Host name or IP Address:

Port number:

User Name:

Password:

Enable schedule mode

Select schedule time

Span 1 : ~ : Next Day

Span 2 : ~ : Next Day

Span 3 : ~ : Next Day

Weekend Saturday and Sunday Only Sunday

Connection Status

Status: Disconnected

Figure 4-27

To enable the GV-GIS connection:

1. **Activate Link:** Enable the monitoring through GV-GIS.
2. **Host Name or IP Address:** Type the host name or IP address of GV-GIS.
3. **Port Number:** Match the communication port on GV-GIS. Or keep the default value 3356.
4. **User Name:** Type a valid user name to log into GV-GIS.
5. **Password:** Type a valid password to log into GV-GIS.
6. **Enable Schedule Mode:** Enable the monitoring through GV-GIS based on the schedule you set in the **Select Schedule Time** section. Refer to *4.5 Recording Schedule* for the same settings.
7. Click **Apply**. The Connection Status should display “Connected” and the connected time.
8. To establish the connection to the second GV-GIS system, click the **Connection 2** tab and repeat the above steps for settings.

For related settings to activate the monitoring through GV-GIS, see *4.1.3 Motion Detection*, and *4.2.2 Input/Output Setting*.

4.3.6 Backup Center

Note the function is only available for **GV-VS04H** (Firmware Version 1.03 or later), **GV-VS11 / 12** (Firmware Version 1.02 or later) and **GV-VS14 / 2420 / 2400 / 2401 / 2820 / 2800 / 21600**.

The connection to GV-Backup Center allows you to back up another copy of recordings and system log to a PC-based GV-Backup Center while the GV-Video Server is saving these data to the attached storage device. If data are lost at where the GV-Video Server is located, the recording data remain safe in a different location.

Backup Center

In this section you can configure the connection to Backup Center and tasks to perform

Backup Center

Activate Link

Host name or IP Address:

Port number:

User Name:

Password:

Backup Video Select all Camera 1 Camera 2

Compact Video Select all Camera 1 Camera 2

Resend all files

Automatic Failover Support

Host name or IP Address:

Port number:

User Name:

Password:

Enable schedule mode

Select schedule time

Span 1 : : ~ : Next Day

Span 2 : : ~ : Next Day

Span 3 : : ~ : Next Day

Weekend Saturday and Sunday Only Sunday

Connection Status

Status: Disconnected

Figure 4-28

To enable the GV-Backup Center connection:

1. **Activate Link:** Enable the connection to GV-Backup Center.
2. **Host Name or IP Address:** Type the host name or IP address of GV-Backup Center.

3. **Port Number:** Match the communication port on GV-Backup Center. Or keep the default value 30000.
4. **User Name:** Type a valid user name to log into GV-Backup Center.
5. **Backup Video:** Select the cameras that you want to back up their recordings to GV-Backup Center.
6. **Compact Video:** Select the cameras that you only want to back up their Key Frames instead of full recordings to GV-Backup Center. This option is useful to save backup time.
7. **Resend all files:** Select this option in case of network interruption. After the network is recovered, all the missing data will be resent to GV-Backup Center again.
8. **Password:** Type a valid password to log into GV-Backup Center.
9. **Enable Schedule Mode:** Enable the GV-Backup Center connection on the schedule you set in the **Select Schedule Time** section. Refer to *4.5 Recording Schedule* for the same settings.
10. Click **Apply**. The Connection Status should display “Connected” and the connected time.

If the GV-Backup Center has a failover server providing uninterrupted backup service in case of a GV-Backup Center failure, you can also configure the connection to the failover server.

1. **Automatic Failover Support:** Enable the automatic connection to the failover server once for times when the connection between GV-Video Server and GV-Backup Center is interrupted.
2. **Host Name or IP Address:** Type the host name or IP address of the failover center.
3. **Port Number:** Match the communication port on the failover server. Or keep the default value 30000.
4. **User Name:** Type a valid user name to log into the failover server.
5. **Password:** Type a valid password to log into the failover server.
6. Click **Apply**.

Note: The **Backup Video**, **Compact Video** and **Resend all files** functions are only available for GV-VS04H (Firmware Version 1.03 or later), GV-VS11 / 12 (Firmware Version 1.02 or later) and GV-VS14 / 2420 / 2400 / 2401 / 2820 / 2800 / 21600.

4.3.7 Video Gateway/Recording Server

Note the function is only available on **GV-VS04H** (Firmware Version 1.03 or later), **GV-VS11 / 12** (Firmware Version 1.02 or later) and **GV-VS14 / 2420 / 2400 / 2401 / 2820 / 2800 / 21600**.

The GV-Video Gateway / GV-Recording Server is a video streaming server designed for large-scale video surveillance deployments. The GV-Video Gateway / GV-Recording Server (with recording capability) can receive up to 128 channels from various IP video devices, and distribute up to 300 channels to its clients. With the GV-Video Gateway / GV-Recording Server, the desired frame rate can be ensured while the CPU loading and bandwidth usage of the IP video devices are significantly reduced.

Connection 1
Connection 2

Video Gateway

In this section you can configure the connection to Video Gateway and tasks to perform

Video Gateway server

Activate Link

Host name or IP Address:

Port number:

User Name:

Password:

Enable schedule mode

Select schedule time

Span 1 : : : Next Day

Span 2 : : : Next Day

Span 3 : : : Next Day

Weekend Saturday and Sunday Only Sunday

Connection Status

Status: Disconnected

Figure 4-29

The GV-Video Server can connect up to two GV-Video Gateway / GV-Recording Server. To send the video images to the GV-Video Gateway or GV-Recording Server, follow the steps below.

1. **Activate Link:** Enable the connection to GV-Video Gateway / GV-Recording Server.
2. **Host Name or IP Address:** Type the host name or IP address of GV-Video Gateway / GV-Recording Server.
3. **Port Number:** Match the communication port on GV-Video Gateway / GV-Recording Server. Or keep the default value 50000.
4. **User Name:** Type a valid user name to log into GV-Video Gateway / GV-Recording Server.
5. **Password:** Type a valid password to log into GV-Video Gateway / GV-Recording Server.
6. **Enable schedule mode:** Enable the GV-Video Gateway / GV-Recording Server connection on the schedule you set in the **Select Schedule Time** section. Refer to 4.5 *Recording Schedule* for the same settings.
7. Click **Apply**. The Connection Status should display “Connected” and the connected time.
8. To establish the connection to the second GV-Video Gateway / GV-Recording Server, click the **Connection 2** tab and repeat the above steps for setup.

4.3.8 ViewLog Server

The ViewLog Server is designed for remote playback function. This server allows you to remotely access the recorded files saved at the GV-Video Server and play back video with the player ViewLog.

Select **Enable** to activate the built-in server. Keep the default port **5552** or modify it if necessary. For details on the remote playback, see 5.2.2 *Playback over Network*.

Viewlog Server Settings

In this section you can configure the connection to Viewlog Server and tasks to perform.

Viewlog Server

Enable	<input checked="" type="checkbox"/>
Port number:	<input type="text" value="5552"/>

Figure 4-30

4.3.9 3GPP/RTSP/ONVIF

The 3GPP / RTSP / ONVIF Server enable video and audio streaming to your 3G-enabled mobile phone or third-party software.

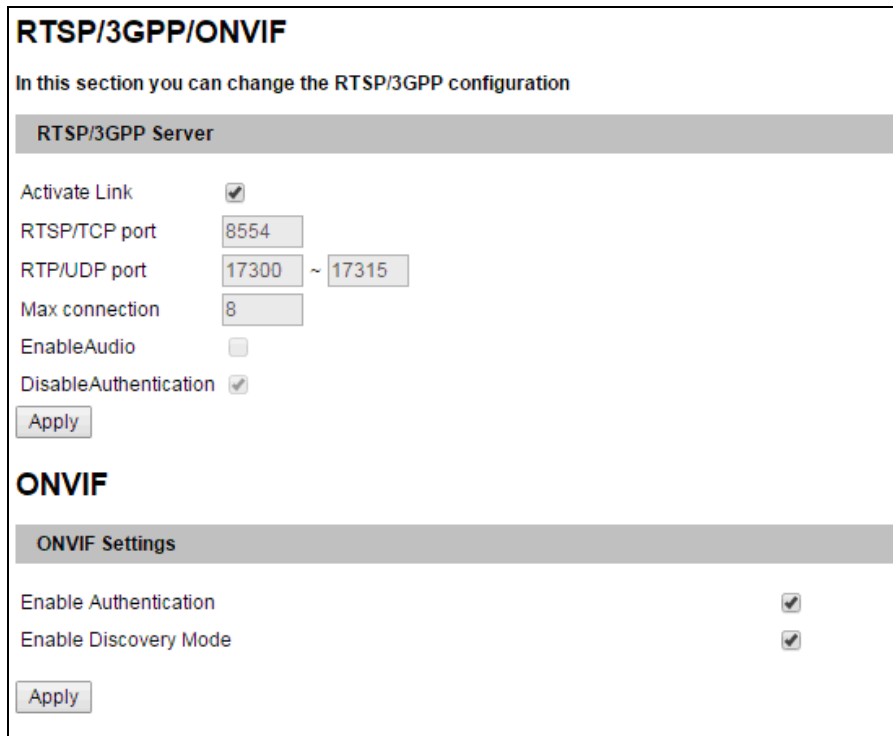

RTSP/3GPP/ONVIF

In this section you can change the RTSP/3GPP configuration

RTSP/3GPP Server

Activate Link

RTSP/TCP port

RTP/UDP port ~

Max connection

EnableAudio

DisableAuthentication

ONVIF

ONVIF Settings

Enable Authentication

Enable Discovery Mode

Figure 4-31

[RTSP / 3GPP Server]

- **Activate Link:** Enable the 3GPP / RTSP / ONVIF service.
- **RTSP/TCP Port:** Keep the default value 8554, or modify it if necessary.
- **RTP/UDP Port:** Keep the default range from 17300 to 17319, or modify it if necessary. The number of ports for use is limited to 20.
- **Max Connection:** Set the maximum number of connections to the GV-Video Server. The maximum value is 20.
- **Enable Audio:** Enable audio streaming.
- **Disable Authentication:** By default, when accessing live view through RTSP command, the ID and password of the GV-Video Server are required. Select this option to disable the authentication prompt. For details on the RTSP command, see *Appendix D*.

For details on remote monitoring with mobile phones, see *10 Mobile Phone Connection*.

[ONVIF]

To enable these options, you must first select the **Activate Link** option above.

- **Enable Authentication:** The ID and password of the camera are required to access the camera when accessing by a third-party software through ONVIF.
- **Enable Discovery Mode:** Allows the third-party software to browse this camera.

Note: The ONVIF protocol is only supported by GV-VS2420 / 2400 (firmware V1.03 or later) / 2401 and GV-VS2820 / 2800 / 21600.

4.4 Monitoring

You can start recording manually, by schedule or by input trigger.

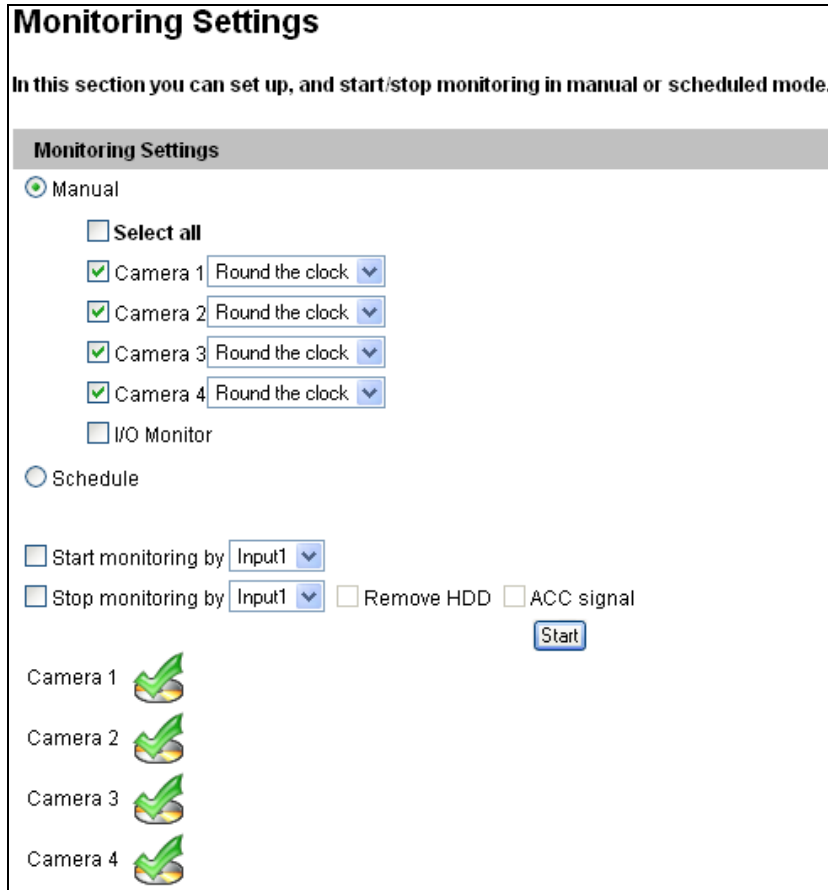

Figure 4-32

[Manual] Manually activates motion detection and input monitoring. Select one of the following options and click the **Start** button.

- **Select all:** Manually start recording and input monitoring as well.
- **Camera x:** Manually start recording. Select the desired camera and the recording mode for recording.
- **I/O Monitor:** Manually start input monitoring. When the input is triggered, its associated camera and output will also be activated for recording and alerting. For input and output settings, see *4.2.2 Input/Output Settings*.

[Schedule] The system starts recording or input monitoring based on the schedule you set. For schedule settings, see *4.5 Recording Schedule*.

[Start monitoring by Input X] This function is only supported by GV-VS04H / 11 / 12 / 14. Start monitoring by the assigned input. When the assigned input is triggered, the system will respond based on your recording or input monitoring settings in above **Manual** or **Schedule** options.

[Stop monitoring by Input X] This function is only supported by GV-VS04H / 11 / 12 / 14. Stop monitoring by the assigned input. When the assigned input is triggered, the system will stop monitoring.

- **Remove HDD:** When the monitoring is stopped by the input trigger, the storage device will also be removed from the system.
- **ACC Signal:** The option is designed for the use of GV-VR605A DC Voltage Regulator. With the GV-VR605A, the GV-Video Server can be installed in the car. When the car ignition is turned off, the GV-Video Server will remove the storage device from the system and turn off automatically. For details, see *GV-VR605A Installation Guide*.

Note: The ACC Signal option is not functional in version 1.05.

[Camera Status Icon]



: Manual recording



: Schedule recording



: On standby



: Enabled for motion detection and input trigger

4.5 Recording Schedule

The schedule is provided to activate recording and I/O monitoring on a specific time each day.

4.5.1 Recording Schedule Settings

You can set up different monitoring schedules for each camera.

Recording Schedule Settings

In this section you can configure schedule time.

Select schedule time

<input checked="" type="checkbox"/> Span 1	Motion	00	:00	~	09	:00	
<input checked="" type="checkbox"/> Span 2	Round the clock	09	:00	~	18	:00	
<input checked="" type="checkbox"/> Span 3	Motion	18	:00	~	00	:00	Next Day
<input type="checkbox"/> Weekend	Round the clock	<input checked="" type="radio"/> Saturday and Sunday <input type="radio"/> Only Sunday					
<input type="checkbox"/> Special Day	Round the clock	(MM/DD)					
	01.	02.	03.	04.			
	05.	06.	07.	08.			
	09.	10.	11.	12.			

Figure 4-33

- **Span 1- Span 3:** Set a different recording mode for each time frame in a day. Each day can be divided into 3 time frames, represented by Span 1 to Span 3. The time frame settings will work from Monday through Sunday.
- **Weekend:** Enable this option to have whole-day monitoring on the weekend and select a recording mode to be used. Define whether your weekend includes **Saturday and Sunday** or **Only Sunday**.
- **Special Day:** Set the recording mode on a specified day.

Note: In Recording Schedule and I/O Monitoring Schedule, if the settings for Special Day conflict with those for Span 1-3 or Weekend, the Special Day settings will get priority.

4.5.2 I/O Monitoring Settings

You can set the schedule for I/O monitoring to start.

Figure 4-34

- **Span 1-3:** Set different time frames in a day to enable I/O monitoring. Each day can be divided into 3 time frames, represented by Span 1 to Span 3. The time frame settings will work from Monday through Sunday.
- **Weekend:** Enable this option to have whole-day monitoring on the weekend and select whether your weekend includes **Saturday and Sunday** or **Only Sunday**.
- **Special Day:** Enable I/O monitoring on a specified day.

4.6 Remote ViewLog

With the Remote ViewLog function, you can play back the files recorded at the GV-Video Server over TCP/IP network.

For the first-time user, you need to install the Remote ViewLog program from <http://www.geovision.com.tw/download/product/>. For remote access to the GV-Video Server, the **ViewLog Server** built in the unit must be enabled. See 4.3.8 *ViewLog Server*.

For details on connecting to the GV-Video Server for playback, see 5.2.2 *Playback over Network*.

4.7 Network

The Network section includes some basic but important network configurations that enable the GV-Video Server to be connected to a TCP/IP network.

4.7.1 LAN

According to your network environment, select among Static IP, DHCP and PPPoE.

LAN Configuration

In this section you can configure Videosever to work inside of LAN.

OptionalNetwork type

Wired Ethernet Select this option to use wired 10/100Mbps ethernet

Wireless Select this option to use Wireless

LAN Configuration

Dynamic IP address Select this option to obtain IP address from a DHCP server Test DHCP

Static IP address Select this option to enter a Static IP address manually

IP Address:

Subnet Mask:

Router/Gateway:

Primary DNS:

Secondary DNS: (Optional)

PPPoE Select this option to establish a DSL connection

Username:

Password:

Wireless Settings

Dynamic IP address Select this option to obtain IP address from a DHCP server Test DHCP

Static IP address Select this option to enter a Static IP address manually

IP Address:

Subnet Mask:

Router/Gateway:

Primary DNS:

Secondary DNS: (Optional)

Figure 4-35

[Optional Network type]

According to the network environment, select **Wired** or **Wireless**.

Before enabling **Wireless**, set up a wireless module first. For details, see 4.7.2 *Wireless-Client Mode*.

[LAN Configuration]

- **Dynamic IP address:** The network environment has a DHCP server. By default, the GV-Video Server will be automatically assigned a dynamic IP address by the DHCP server. To check the current IP address, click the **Test DHCP** button.
- **Static IP address:** Assign a static IP or fixed IP to the GV-Video Server. Type the GV-Video Server's IP address, Subnet Mask, Gateway and DNS Server parameters.

If no DHCP server exists in your network environment, the following default IP address will be assigned to the GV-Video Server.

Parameters	Default
IP address	192.168.0.10
Subnet Mask	255.255.255.0
Router/Gateway	192.168.0.1
Primary DNS server	192.168.0.1
Secondary DNS server	192.168.0.2

- **PPPoE:** Establish the connection to your ISP. Type the Username and Password provided by the ISP to establish the connection. However, if the IP address provided by your ISP is dynamic, use the DDNS function to obtain a domain name linking to the unit's changing IP address before enabling the PPPoE function. For details on Dynamic DNS Server Settings, see *4.7.3 Advanced TCP/IP*.

Note: To establish connection through a broadband modem, you may refer to this article: ftp://geo-demo-japan.dipmap.com/Technotice/GV_IP_Devices/How_to_access_GV-IP_Camera_through_broadband_modem.pdf

[Wireless Settings]

Before enabling **Wireless**, set up a wireless module first. For details, see *4.7.2 Wireless-Client Mode*. Then you can select the **Dynamic IP Address** or **Static IP Address** in this section for the wireless LAN. By default, the following static IP address will be applied for wireless connection.

Parameters	Default
IP address	192.168.100.10
Subnet Mask	255.255.255.0
Router/Gateway	192.168.0.1
Primary DNS server	192.168.0.1
Secondary DNS server	192.168.0.2

4.7.2 Wireless-Client Mode

To use the wireless function, a wireless LAN USB adaptor is required. For supported wireless LAN adaptors, see *Appendix B*.

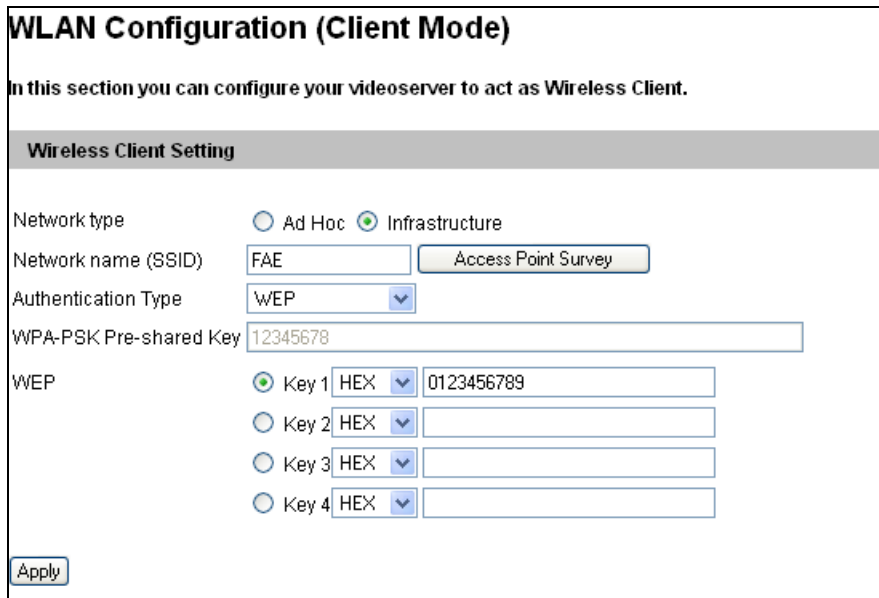

Figure 4-36

- **Network type:** Select the network mode **Ad Hoc** or **Infrastructure**.
 - ⊙ **Infrastructure:** Via the Access Point to connect to the Internet. This mode further gives wireless access to the Internet or data sharing under a previously wired environment.
 - ⊙ **Ad-Hoc:** A Peer-to-Peer mode. This mode connects to other computer with the WLAN card, and does not need the Access Point to connect to each other.
- **Network name (SSID):** The SSID (Service Set Identify) is a unique name that identifies a particular wireless network. Type SSID of the Wireless LAN group or Access Point you are connecting to.
 - ⊙ **Access Point Survey:** Click this button to search all the available Access Points (Infrastructure mode) and wireless stations (AD-Hoc mode) within the range of your WLAN card.
- **Authentication Type:** Select one of these network authentications and data encryptions: **Disable**, **WEP**, **WPAPSK-TKIP**, **WPAPSK-AES**, **WPA2PSK-TKIP** or **WPA2PSK-AES**.
 - ⊙ **Disabled:** No authentication is needed within the wireless network.
 - ⊙ **WEP (Wired Equivalent Privacy):** A type of data encryption. Type up to four WEP Keys in HEX or ASCII format. Note that if you use HEX format, only digits 0-9 and letters A-F, a-f are valid.

- ⦿ **WPAPSK-TKIP** and **WPA2PSK-TKIP**: Type WPA-PSK (Pre-Shared Key) for data encryption.
- ⦿ **WPAPSK-AES** and **WPA2PSK-AES**: Type WPA-PSK (Pre-Shared Key) for data encryption.

Note:

1. Your encryption settings must match those used by the Access Points or wireless stations in which you are connecting to.
 2. When both WiFi and 3G are available, the device will automatically choose WiFi for network connection. This function is only supported by GV-VS12 / 14 / 2420 / 2400 / 2401 / 2820 / 2800 / 21600.
-

4.7.3 Advanced TCP/IP

This section introduces the advanced TCP/IP settings, including DDNS Server, HTTP port, HTTPS port, streaming port and UPnP.

Advanced TCP/IP

In this section you can set the advanced TCP/IP configuration

Dynamic DNS Server Settings

In this section you can configure your Videosever to obtain a domain name by using a dynamic IP.

Enable

Service Provider: Geovision DDNS Server ex: Register Geovision DDNS Server

Host Name:

User Name:

Password:

Update Time: [Refresh](#)

HTTP Port Settings

In this section you can change the default HTTP port number (80) to any port within the range 1024-65535. It is a simple method to increase system security using port mapping. You can configure HTTP connection to an alternative port.

HTTP Port:

HTTPS Settings

In this section you can change the default HTTPS port number (443) to any port within the range 1024-65535. It is a simple method to increase system security using port mapping. You can configure HTTPS connection to an alternative port.

External storage is not available. Cannot upload customized certification and private key.

Enable

HTTP Port:

Use customized certification and private key. External storage is necessary.

Certification:

Private Key:

Password:

Videosever Streaming Port Settings

In this section you can configure Streaming connection from a determine port. The default setting is 10000.

VSS Port:

UPnP Settings

In this section you can enable or disable UPnP function.

UPnP: Enable Disable

UPnP/DLNA: Enable Disable

QoS Settings

QoS DSCP Settings. The DSCP value can be in decimal or hexadecimal format between 0-63

Live Video DSCP:

Figure 4-37

[Dynamic DNS Server Settings]

DDNS (Dynamic Domain Name System) provides a convenient way of accessing the GV-Video Server when using a dynamic IP. DDNS assigns a domain name to the GV-Video Server, so that the Administrator does not need to go through the trouble of checking if the IP address assigned by DHCP Server or ISP (in xDSL connection) has changed.

Before enabling the DDNS function, the Administrator should have applied for a Host Name from the DDNS service provider's website. There are 2 providers listed for the GV-Video Server: GeoVision DDNS Server and DynDNS.org.

To enable the DDNS function:

1. **Enable:** Enable the DDNS function.
2. **Service Provider:** Select the DDNS service provider you have registered with.
3. **Host Name:** Type the host name used to link to the GV-Video Server. For the users of GeoVision DDNS Server, it is unnecessary to fill the field because the system will detect the host name automatically.
4. **User Name:** Type the user name used to enable the service from the DDNS.
5. **Password:** Type the password used to enable the service from the DDNS.
6. Click **Apply**.

[HTTP Port Settings]

The HTTP port enables connecting the GV-Video Server to the Web. For security integration, the Administrator can hide the server from the general HTTP port by changing the default HTTP port of 80 to a different port number within the range of 1024 thru 65535.

[HTTPS Settings]

By enabling the Hypertext Transfer Protocol Secure (HTTPS) settings, you can access the camera through a secure protocol. You can use self-generated Certificate and Private Key or the ones verified by the SSL authority. Click **Browse** to locate the Certificate and Private Key files and type the password if the .pem files are protected by password. Click **Apply**. The Web interface will be restarted and you will need to log in again.

Note this function is only available for **GV-VS04H** (Firmware V1.03 or later), **GV-VS11 / 12** (Firmware Version 1.04 or later) and **GV-VS14 / 2420 / 2400 / 2401 / 2820 / 2800 / 21600**.

Note: The .pem file format is supported by Certificate and Private Key.

[Video Server Streaming Port Settings]

The VSS port enables connecting the GV-Video Server to the GV-DVR / NVR / VMS. The default setting is 10000.

[UPnP Settings]

- **UPNP:** UPnP (Universal Plug & Play) is a networking architecture that provides compatibility among networking equipment, software and peripherals of the 400+ vendors that are part of the Universal Plug and Play Forum. It means that they are listed in the network devices table for the operating system (such as Windows XP) supported by this function. Enabling this function, you can connect to the GV-Video Server directly by clicking on the GV-Video Server listed in the network devices table.
- **DLNA:** allows the DLNA certified devices to automatically communicate with each other once connected to the same network. The function is currently supported with Windows Media Player for recording playback.

Note:

1. The DLNA function is only supported by GV-VS04H / 11 / 12 / 14.
 2. The DLNA function is only supported with Windows Media Player version 1.1 or later. To play back recorded videos with Windows Media Player, you must have installed GeoVision codec or accessed GV-Video Server Web interface.
 3. The DLNA function does not support the connection to TV.
-

[QoS Settings]

The Quality of Service (QoS) is a bandwidth control mechanism that guarantees delay-sensitive data flows, such as voice and video streams, to obtain a certain amount of bandwidth in keeping the streaming smooth.

To apply QoS to the GV-Video Server, all network routers must support QoS and QoS must be enabled on these devices. To enable the QoS on the GV-Video Server, enter a Differentiated Services Code Point (DSCP) value. This value is a field in an IP packet that enables different levels of services for the network traffic. When the video stream from the GV-Video Server reaches a router, the DSCP value will tell the router what service level to be applied, e.g. the bandwidth amount. This value ranges from 0 to 63 in decimal format. The default value is 0, meaning QoS is disabled.

Note this function is only available for **GV-VS04H** (Firmware Version 1.05 or later), **GV-VS11 / 12** (Firmware Version 1.05 or later) and **GV-VS14 / 2420 / 2400 / 2401 / 2820 / 2800 / 21600**.

4.7.4 UMTS

UMTS stands for Universal Mobile Telephone System. UMTS is a third-generation (3G) broadband, packet-based transmission of text, digitized voice, video, and multimedia at data rates up to 2 megabits per second. UMTS offers a consistent set of services to mobile computer and phone users, no matter where they are located in the world.

After a mobile broadband device (supporting UMTS, HSDPA, etc.) is attached to the USB port on the rear panel and the UMTS function is enabled, the GV-Video Server can have wireless broadband access. For supported mobile broadband devices, see *Appendix C*.

The Virtual Private Network (VPN) over a UMTS connection is also configurable in the setting page.

UMTS Settings

In this section you can configure the UMTS settings

UMTS Settings

Set Up UMTS Device

Enable

PIN Number

Access Point Name (APN)

Username

Password

Maximum Transmission Unit

Retain UMTS connection

Check Interval

Enable VPN Connection

Check Target IP Address

UMTS Authentication Protocol

Enable schedule mode

EnableDNS

Primary DNS:

Secondary DNS: (Optional)

Select schedule time

Span 1 : : : Next Day

Span 2 : : : Next Day

Span 3 : : : Next Day

Weekend Saturday and Sunday Only Sunday

3GConnection Status

Disconnection

Figure 4-38

- **PIN number:** Type the PIN number that is provided by your network operator.
- **Access Point Name (APN):** Type Access Point Name that is provided by your network operator.
- **Username:** Type a valid username to enable the UMTS service from your network operator.
- **Password:** Type a valid password to enable the UMTS service from your network operator.
- **Maximum Transmission Unit:** Type the Maximum Transfer Unit (MTU). The default value is 1500.
- **Retain UMTS Connection:** Select this option to check the UMTS connection status and use the drop-down list to specify the desired time length for check frequency. The GV-Video Server will rebuild the connection if disconnection is detected.
- **Enable VPN Connection:** Select this option to enable the VPN (Virtual Private Network) connection. Type the target IP address in the **Check Target IP Address** field.
- **UMTS Authentication Protocol:** Use the drop-down list to select the UMTS Authentication Protocol provided by your network operator.
- **Enable Schedule Mode:** Starts the UMTS connection automatically based on the schedule you set in the **Select Schedule Time** section. Refer to *4.5 Recording Schedule* for the same settings.
- **Enable DNS:** Optionally type up to two DNS servers of your network operator.
- **3G Connection Status:** Indicates the connection status of UMTS or VPN.

Note: When both WiFi and 3G are available, the device will automatically choose WiFi for network connection. This function is only supported by GV-VS12 / 14 / 2420 / 2400 / 2401 / 2820 / 2800 / 21600.

4.7.5 Multicast

Note this function is only available for **GV-VS04H** (Firmware Version 1.03 or later), **GV-VS11 / 12** (Firmware Version 1.05 or later) and **GV-VS14**.

The multicast provides a mechanism for sending a single video and audio stream to a group of hosts. Only the hosts that have joined a multicast group can send and receive the multicast streams. The multicast streams are only sent to hosts on a local network.

This configuration page provides two settings. One is to allow the GV-Video Server to join a multicast group. The other is to allow the GV-Video Server to receive audio broadcasting from other hosts in a multicast group.

Multicast Settings

In this section you can configure the multicast settings of the video server.

Multicast Settings (Only Support CIF or QCIF Resolution)

Enable:

Multicast Host Name:

Multicast Info Update Period: seconds

Multicast Data IP:

Multicast Data Port:

Multicast Video: Camera 1 Camera 2

Multicast Audio: Camera 1 Camera 2

Enable Encryption

Encryption Key:

Enable Audio Callback

Assign IP to receive Audio:

Assign Port to receive Audio:

Figure 4-39

- **Multicast Host Name:** Name the GV-Video Server in a multicast group.
- **Multicast Info Update Period:** Set the time length between each update of multicast streams.
- **Multicast Data IP:** Type the IP address used for multicasting. The default IP address is 224.1.1.2.
- **Multicast Data Port:** Type the port used for multicasting. The default value is 8300.
- **Multicast Video:** Select the camera to send its video through multicasting.
- **Multicast Audio:** Select the audio to send its audio through multicasting.

- **Enable Encryption:** Enable this option and type the Encryption Key to secure multicast streams. The hosts in the multicast group will need to enter the Key to access the video and audio streams.
- **Enable Audio callback:** Enable this option to receive audio broadcasting from hosts in the multicast group. Specify the IP address and port number to receive the audio broadcast. The default IP address is 224.1.1.3 and port number is 8400.

To perform the multicast and listen to audio broadcasting, see *4.1.1 Multicast*.

4.7.6 IP Filter

The Administrator can set IP filtering to restrict access to the GV-Video Server.

Figure 4-40

To enable the IP Filter function:

1. **Enable IP Filtering:** Check the option to enable the function.
2. **Web Service Access Policy:** Select a policy you want to apply to manage the access of IP addresses.
3. **Filtered IP:** Type the IP address you want to restrict access of.
4. **Action to take:** Select the action of **Allow** or **Deny** to be taken for the IP address(es) you have specified.
5. Click **Apply**.

Note: **Web Service Access Policy** is only supported by GV-VS2420 / 2400 / 2820 / 2800. If you select **Disallow access from anywhere**, add the IP address of your GV-Video Server to the filtered IP list and allow your own access.

4.7.7 SNMP Setting

The Simple Network Management Protocol (SNMP) allows you to monitor the status of the camera through SNMP network management software. Note this function is only available for **GV-VS04H** (Firmware Version 1.05 or later), **GV-VS11 / 12** (Firmware Version 1.05 or later) and **GV-VS14 / 2420 / 2400 / 2401 / 2820 / 2800 / 21600**.

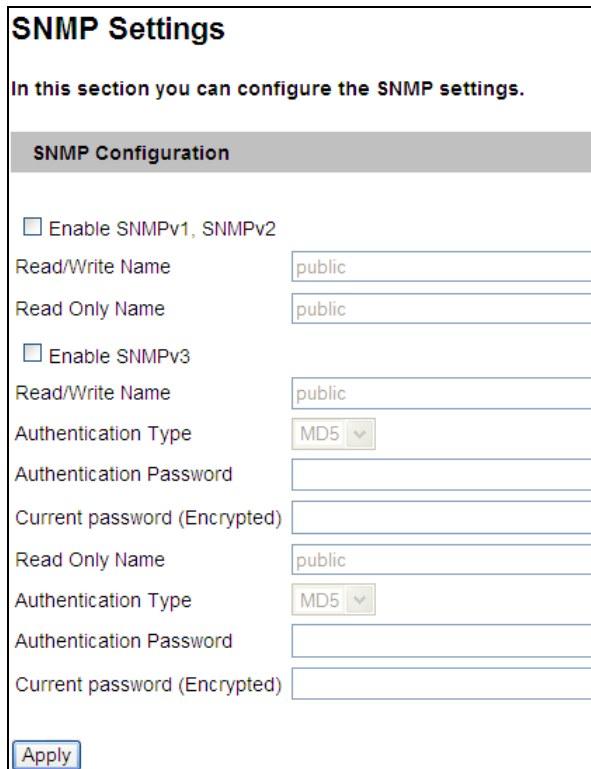

SNMP Settings

In this section you can configure the SNMP settings.

SNMP Configuration

Enable SNMPv1, SNMPv2

Read/Write Name

Read Only Name

Enable SNMPv3

Read/Write Name

Authentication Type

Authentication Password

Current password (Encrypted)

Read Only Name

Authentication Type

Authentication Password

Current password (Encrypted)

Figure 4-41

1. Select **Enable SNMPv1 SNMPv2c** to enable the function.
2. To enable access to **Read/Write Name**, type a name string. This will serve as a password to allow read and write access **to the camera from the SNMP software**.
3. To enable **Read only Name**, type a name string to allow read-only access to the camera from the SNMP software.
4. For a more secured connection, select **Enable SNMPv3** to enable SNMP version 3.
5. To enable access to SNMPv3 **Read/write Name**, type a name string.
6. Select an **Authentication Type** to use for SNMP requests.
7. Type the **Authentication Password** and **Current password (Encrypted)**. You will need to type these passwords in the SNMP software to be able to access the camera.
8. To enable access to SNMPv3 Read only name, follow steps 5 to 7.
9. Click **Apply** to save the settings.

4.8 Management

The Management section includes the settings of data and time, USB mass storage device and user account. Also, you can view the firmware version and execute certain system operations such as language setting.

4.8.1 Date and Time Settings

The date and time settings are used for date and time stamps on the image.

Date and Time Settings

In this section you can configure time and date or just synchronize with a NTP server.

Date and Time on Videoserver

Wed Jul 17 14:15:18 2013

Time Zone

(GMT+08:00) China, Hong Kong, Australia Western, Singapore, Taiwan, Russia ▼

Enable Daylight Saving Time

Start (MM/dd/hh/mm)

End (MM/dd/hh/mm)

Synchronized with a Network Time Server

Synchronized with Network Time Server (NTP)

Host name or IP Address:

Update period: 24 hours; Update Time: :

Synchronized with your computer or modify manually

Modify manually

Date (yyyy/mm/dd)

Time (hh:mm:ss)

Synchronized with your computer

Date and time overlay setting

Show date as ▼

(This is a format of date where yyyy stands for year in 4 digits or yy in 2 digits, mm stands for month, and dd stands for day)

Display order Date prior to time (Ex.2007/05/21 17:00:00)

Time prior to date(Ex.17:00:00 2007/05/21)

Figure 4-42

[Date & Time on Video server] Displays the current date and time on the GV-Video Server.

[Time Zone] Sets the time zone for local settings. Select **Enable Daylight Saving Time** to automatically adjust the GV-Video Server for daylight saving time. Type the Start Time and End Time to enable the daylight saving function. To automatically synchronize the Daylight Saving Time with the GV-DVR / NVR, see *7.1.1 Customizing GV-Video Server Settings*.

[Synchronized with a Time Server] By default, the GV-Video Server uses the timeserver of time.windows.com to automatically update its internal clock every 24 hours. You can define the update time. The host name or IP setting can also be changed to the timeserver of interest.

[Synchronized with your computer or manually] Manually changes the GV-Video Server's date and time. Or, synchronize the GV-Video Server's date and time with those of the local computer.

[Date and time overlay setting] Select the display format of date and time stamps on the image. For this function to work, you must also enable the **Overlaid with date stamps** and **Overlaid with time stamps** options in Figure 4-5.

4.8.2 GPS Maps Settings

Note this function is only available for **GV-VS04H / 12 / 14**.

The GV-Video Server supports the Global Position System (GPS) for active vehicle tracking and location verification. The vehicle location will be tracked by Google Maps. Before using the Google Maps, you must sign up for a Google Maps API key. Then, enter the registered Maps API Key, the longitude and latitude of the GV-Video Server, and location name to enable this function.

If your GV-Video Server is installed on an active vehicle, it is not necessary to enter **Longitude** and **Latitude**, since the vehicle location will be traced by GPS. However, if your GV-Video Server has a fixed position without GPS function, then it is required to enter its **Longitude** and **Latitude** so its correct location can be displayed on the Google Maps.

GPS Maps

In this section you can configure the GPS Maps settings.

GPS Maps Settings

Sign up for a Google Maps API key [Link to the Google Maps API](#)

Google Maps API Key

Longitude (Ex.121.565=E121.565. -10.25=W10.25)

Latitude (Ex.25.081=N25.081. -10.25=S10.25)

Location Name

Figure 4-43

For details on the GPS application, see *6.3 GPS Tracking*.

4.8.3 Storage Settings

Based on Linux file system, the GV-Video Server supports external USB mass storage devices for video and audio recording. Normally USB mass storage devices are ready for Windows OS. Therefore, you need to format the devices by using the following Storage Settings. After being formatted, the storage devices will be ready to use by Linux OS of the GV-Video Server.

Note:

1. The GV-Video Server does not support USB2.0 to SATA / IDE cable for external USB storage connection.
2. GV-VS04H / 11 / 12 / 14 support up to 2 TB hard disk, GV-VS2420 / 2400 supports up to 4 TB hard disk, and GV-VS2401 / 2820 / 2800 / 21600 supports up to 6 TB hard disk.
3. It is not recommended to use the flash USB drive with the GV-Video Server because of its slow read and write speed.

Storage Settings

In this section you can configure the disk storage to archive videos and events.

Storage Settings

Enable recycling
 Stop recording or recycle disk when free space of disk is smaller than

Keep days (1-255)

Disk Information

Disk No.	Total Size	Used Size	Free space	Utilization	Remove	Format
Disk0	1862.852	125.388	1737.464	6%	<input type="button" value="Remove"/>	<input type="button" value="Format"/>

Partition Information

Disk No.	Partition No.	Total Size	Used Size	Free space	Utilization	Status	Format
Disk0	10	195.305	101.342	93.986	51%	OK	<input type="button" value="Format"/>
Disk0	11	195.305	0.240	195.065	0%	OK	<input type="button" value="Format"/>
Disk0	12	195.305	0.187	195.117	0%	OK	<input type="button" value="Format"/>
Disk0	13	195.305	0.187	195.117	0%	OK	<input type="button" value="Format"/>
Disk0	14	105.152	0.187	104.988	0%	OK	<input type="button" value="Format"/>
Disk0	5	195.305	14.788	180.540	7%	OK	<input type="button" value="Format"/>
Disk0	6	195.305	7.964	187.365	4%	OK	<input type="button" value="Format"/>
Disk0	7	195.305	0.187	195.117	0%	OK	<input type="button" value="Format"/>
Disk0	8	195.305	0.187	195.117	0%	OK	<input type="button" value="Format"/>
Disk0	9	195.305	0.187	195.117	0%	OK	<input type="button" value="Format"/>

(Unit: Gigabyte)

Figure 4-44

[Storage Settings]

If the **Enable recycling** option is checked, when the space of the USB mass storage device is lower than the specified space, the system will either write the data to another device or overwrite the oldest recorded files.

If the **Enable recycling** option is not checked, the system will stop recording when the specified space is reached.

- **Keep days (1-255):** Specify the number of days to keep the files from 1 day to 255 days. When both **Keep days** and **Enable recycling** are selected, the system applies whichever condition comes first. For example, if the specified smallest amount of storage space is reached earlier than the designated keep days, then recycle is applied first.

[Disk Information]

This section shows the details of the attached storage devices.

[Partition Information]

This section shows the partition details of the attached storage devices.

To add a USB mass storage device:

1. Attach the device to the GV-Video Server.
2. Click the **Format** button.

After the format is complete, the partition information will display.

To remove a USB mass storage device:

1. Click the **Remove** button.
2. When you are prompted to ensure the action, click **Yes**. The page will be refreshed and the partition information will be cleaned.
3. Remove the device from the GV-Video Server.

Note:

1. If **Enable Recycle** is selected, the available space of the USB mass storage device must be higher than the space you specified at the **Stop recording or recycle disk when free space of disk is smaller than x** option. Otherwise no video will be recorded.
 2. The recording data may be lost if you remove the USB mass storage device during recording.
 3. The storage device will be divided into three partitions after being formatted. Each partition has a maximum capacity of 200 GB.
 4. If you do not remove the USB storage device properly, the data cannot be read in another computer. In this case, re-plug the storage device back to the GV-Video Server. The system will repair the data automatically. When the system is repairing the data, the Remove field will display “Repairing”.
-

4.8.4 User Account

You can change the login name and password of Administrator, Guest and FTP Server User.

- The default Administrator login name and password are **admin**.
- The default Guest login name and password are **guest**.
- To allow a Guest user log in without entering name and password, select **Disable authentication for guest account**. To prevent automatic logout of an Administrator / Guest account user after reboot, select **Disable auto logout when reboot**.
- The default FTP Server login name and password are **ftpuser / 123456**.

Note: For GV-VS2420 / 2400 / 2820 / 2800, the system will remind and direct you to change your account and password if you are logging in for the first time or the password strength is too weak.

User Account

In this section you can change the administrator account and password

Administrator Account

Username:

Old Password:

New Password:

Confirm Password:

Guest User Account

Username:

Old Password:

New Password:

Confirm Password:

Advanced Setting

Disable authentication for guest account

Disable auto logout after reboot

FTP Server User Account

Username:

Old Password:

New Password:

Confirm Password:

Figure 4-45

4.8.5 Log Information

The **Startup time log** section contains every start time of the GV-Video Server. The start time is recorded on the local storage device, so the information is only available when a storage device is connected to the GV-Video Server.

The **Debug Messages** section contains dump data that is used by service personnel for analyzing problems.

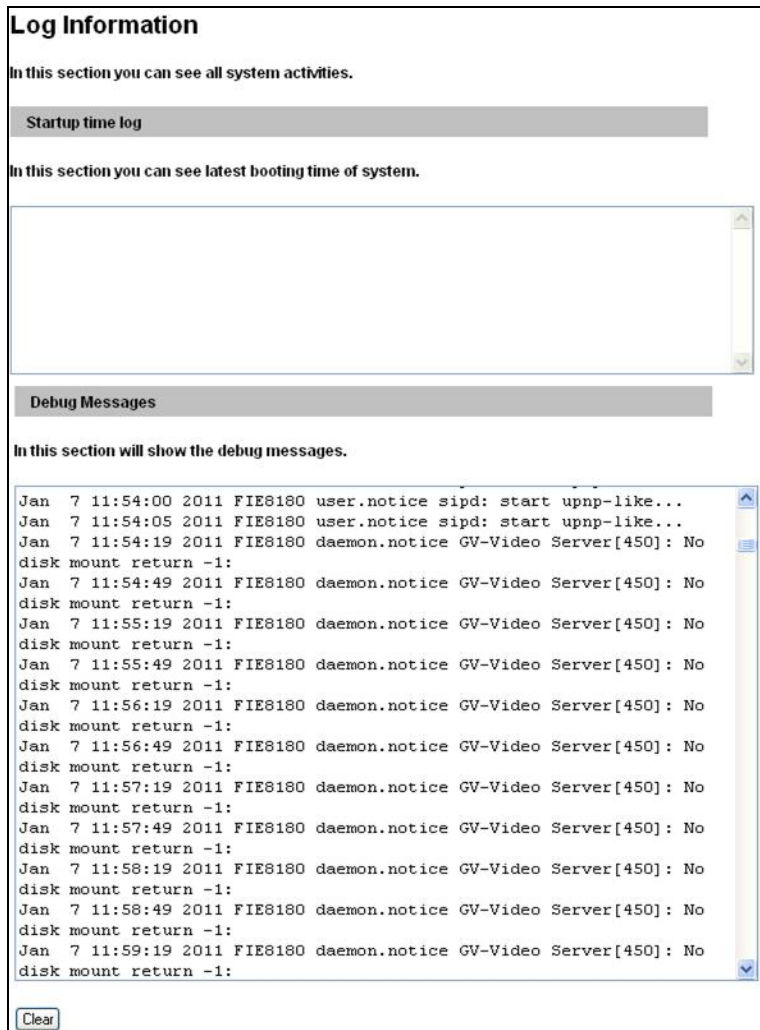

Log Information

In this section you can see all system activities.

Startup time log

In this section you can see latest booting time of system.

Debug Messages

In this section will show the debug messages.

```
Jan 7 11:54:00 2011 FIE8180 user.notice sipd: start upnp-like...
Jan 7 11:54:05 2011 FIE8180 user.notice sipd: start upnp-like...
Jan 7 11:54:19 2011 FIE8180 daemon.notice GV-Video Server[450]: No
disk mount return -1:
Jan 7 11:54:49 2011 FIE8180 daemon.notice GV-Video Server[450]: No
disk mount return -1:
Jan 7 11:55:19 2011 FIE8180 daemon.notice GV-Video Server[450]: No
disk mount return -1:
Jan 7 11:55:49 2011 FIE8180 daemon.notice GV-Video Server[450]: No
disk mount return -1:
Jan 7 11:56:19 2011 FIE8180 daemon.notice GV-Video Server[450]: No
disk mount return -1:
Jan 7 11:56:49 2011 FIE8180 daemon.notice GV-Video Server[450]: No
disk mount return -1:
Jan 7 11:57:19 2011 FIE8180 daemon.notice GV-Video Server[450]: No
disk mount return -1:
Jan 7 11:57:49 2011 FIE8180 daemon.notice GV-Video Server[450]: No
disk mount return -1:
Jan 7 11:58:19 2011 FIE8180 daemon.notice GV-Video Server[450]: No
disk mount return -1:
Jan 7 11:58:49 2011 FIE8180 daemon.notice GV-Video Server[450]: No
disk mount return -1:
Jan 7 11:59:19 2011 FIE8180 daemon.notice GV-Video Server[450]: No
disk mount return -1:
```

Figure 4-46

4.8.6 System Log

Note the function is only available on **GV-VS04H** (Firmware Version 1.03 or later), **GV-VS11 / 12** (Firmware Version 1.02 or later) and **GV-VS14**.

The System Log records the events in four types of logs: **System Event**, **Monitoring Event**, **I/O Event** and **Login/Logout Event**. With the System Log, you can search and obtain the detailed information of an event. To use the System Log, a storage device is required to connect to the GV-Video Server.

1. For the first-time user of the System Log, first click **Create** to create a system log database (access file) on the attached storage device.

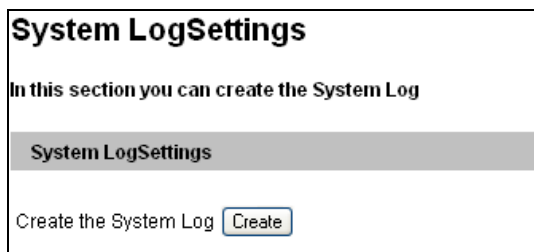

Figure 4-47

Note: If you have created the System Log on the storage device, clicking **Create** again will clean your System Log.

2. Select the log type **System Event**, **Monitoring Event**, **I/O Event** or **Login/Logout** from the left menu of the Web interface.
3. Specify the filtering criteria. For example, we want to know the login and logout information during a specific period of time.
4. Click **Query**. The filtering results may look like the figure below.

Login / Logout Query						
Device Name	<input checked="" type="checkbox"/> GV-VS04A	Status	Select all			
Mode	Select all	Time	2009-10-29 00:00 ~ 2009-10-29 23:59			
Login / Logout	Select all	User Name				
DST	Select all					
<input type="button" value="Query"/> <input type="button" value="Reset"/>						
The page show record 1-2, total number of records : 2 total number of pages : 1						
Query Result List						
Device Name	User Name	Login / Logout	Time	Mode	Status	DST
GV-VS04A	admin	Login	2009-10-29 19:07:36	Local	Success	N
GV-VS04A	admin	Logout	2009-10-29 19:07:27	Local	Success	N
<input type="button" value="Export CSV"/> <input type="button" value="Export Word"/>						

Figure 4-48

4.8.7 Tools

This section allows you to execute certain system operations and view the firmware version.

Additional Tools

In this section you can set the additional tools

Host Settings

In this section you can determine a hostname and camera name for identification.

Host Name

Auto Reboot Setup

In this section you can set the system's auto reboot time.

Enable

Day Interval days

RebootTime :

Repair Recording Database

Click Apply to repair the database when you cannot play back recordings.

Repairing Status

Unknown

Firmware Version

In this section you can see Videosever firmware version.

System Settings

Restore to factory default settings

Internal Temperature

Current chipset temperature inside camera is °C / °F

Reboot

Do you wish to reboot now?

Figure 4-49

[Host Settings] Enter a descriptive name for the GV-Video Server.

[Auto Reboot Setup] Select **Enable** to activate automatic reboot and specify the time for reboot in the sub fields.

- **Day Interval:** Type the day interval between each reboot.
- **Reboot Time:** Use the drop-down lists to specify the time for automatic reboot.

Note this function is only available for **GV-VS04H** (Firmware Version 1.03 or later), **GV-VS11 / 12** (Firmware V1.04 or later) and **GV-VS14 / 2420 / 2400 / 2401 / 2820 / 2800 / 21600**.

[Repair Record Database] Click **Apply** to repair the database when errors occur while playing back the recordings with the Remote ViewLog player. Problems can occur when there are errors in firmware or damages to the storage device.

Note this function is only available for **GV-VS04H** (Firmware Version 1.03 or later), **GV-VS11 / 12** (Firmware V1.04 or later) and **GV-VS14 / 2420 / 2400 / 2401 / 2820 / 2800 / 21600**.

[Repair Database Status] This field displays the repairing status of database.

[Firmware Update] This field displays the firmware version of the GV-Video Server.

[System Settings] Clicking the **Load Default** button will make the GV-Video Server restore factory default settings. The Ready LED on the front panel will turn off. Wait until the Ready LED turns on and re-log in the server. After applying the default settings, you will need to configure the GV-Video Server's network setting again.

[Internal Temperature] This field displays the current chipset temperature inside the GV-Video Server. Note this function is only available for **GV-VS14 / 2420 / 2400 / 2401 / 2820 / 2800 / 21600**.

[Reboot]

Clicking the **Reboot** button will make the GV-Video Server perform software reset. The Ready LED on the front panel will turn off. Wait until the Ready LED turns on and re-log in the server.

4.8.8 Language

You can select the language for the Web interface.

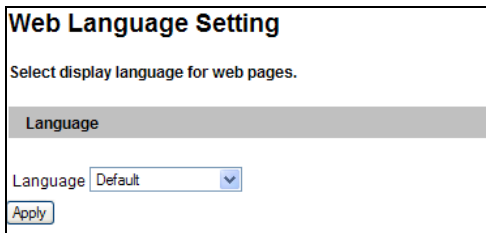

Web Language Setting

Select display language for web pages.

Language

Language: Default

Apply

Figure 4-50

Use the **Language** drop-down list to select a language for the Web interface. By default, the language on the Web interface will be the same with the one used for the operating system.

Chapter 5 Recording and Playback

The GV-Video Server can record down video/audio directly to the attached USB mass storage device. And you can play back the recorded files on the GV-DVR / NVR / VMS or over the TCP/IP network.

5.1 Recording

To enable the recording function:

1. Attach the USB mass storage device to the GV-Video Server. See *4.8.3 Storage Settings*.
2. To set up the pre-recording, post-recording or audio recording, see *4.1.2 Video Settings*.
3. To set up the schedule for video recording or I/O monitoring, see *4.5 Recording Schedule*.
4. To configure the areas and sensitivity values for motion detection, see *4.1.3 Motion Detection*.
5. To start recording by the triggering of input device, configure the operation of I/O devices. See *4.2.2 Input/Output Settings*.
6. To start recording and I/O monitoring, see *4.4 Monitoring*.

The GV-Video Server will start recording in case of motion detection, I/O trigger, or during the scheduled time.

5.2 Playback

Two methods are available to play back the video files recorded at the GV-Video Server:

- Playback using the USB mass storage device by attaching it directly to the GV-DVR / NVR / VMS.
- Playback using the Remote ViewLog function over the TCP/IP network

5.2.1 Playback Using USB Mass Storage Device

You can play back the files recorded at the GV-Video Server by attaching the USB mass storage device to the GV-DVR / NVR / VMS. However, the GV-DVR / NVR / VMS are run on Windows system while the files recorded at GV-Video Server are of Linux file system. To enable Windows to recognize Linux files, you need to install the **ExtFS** program from GeoVision Website.

1. Visit GeoVision download page at <http://www.geovision.com.tw/download/product/>, type the model name of your GV-Video Server on the search bar.

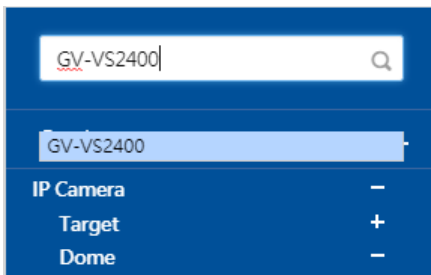

2. Select **Supplemental Utilities** from the drop-down list, and click the **Download** icon  of **ExtFS - ExtFS File System Driver**. Follow the onscreen instructions for installation.
3. The **ExtFS for Windows** automatically mounts the USB mass storage device onto your Windows system.

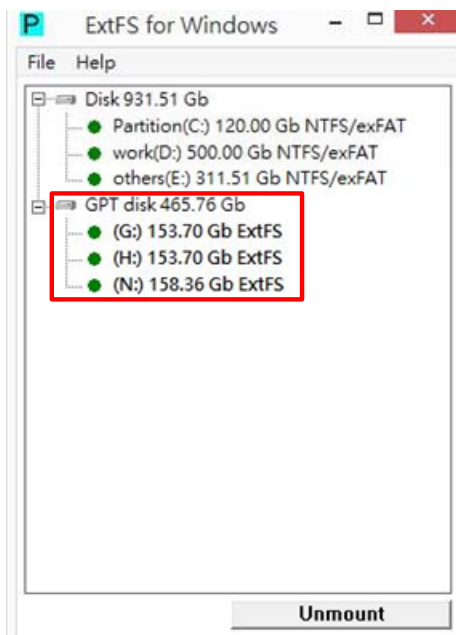



Figure 5-1

4. Access the recording files from the specified disk drive of your computer.
5. Run **ViewLog**.
6. Click the **Advanced** button , select **Reload Database** and click **Video Server/Compact DVR**. This dialog box appears.

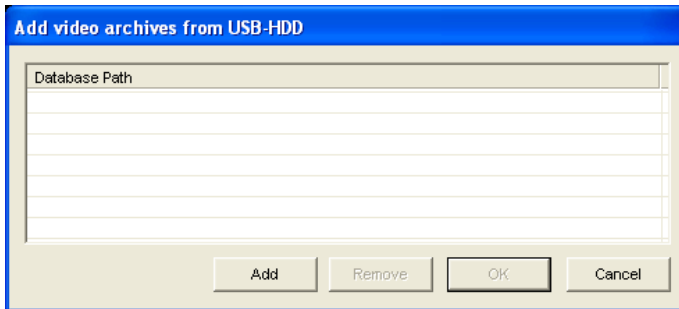

Figure 5-2

7. Click **Add** to assign the disk drive.
8. Click **OK** to load the data to the ViewLog for playback.

5.2.2 Playback over Network

With the Remote ViewLog function, you can play back the files recorded at the GV-Video Server over TCP/IP network.

Installing Remote ViewLog

For first-time users, install Remote ViewLog from GeoVision Website. Once installed, you can access this option from GV-Video Server's Web interface. To install Remote ViewLog, follow the steps below:

1. Go to GeoVision download page: <http://www.geovision.com.tw/download/product/>
2. Select **Supplemental Utilities** from the drop-down list, and click the **Download** icon



of **GV-Remote ViewLog**.

Playing Back from Remote ViewLog

1. You must enable **ViewLog Server** on the GV-Video Server's Web interface to allow remote access. See 4.3.8 *ViewLog Server*.
2. Run the **Remote ViewLog** program and select **Remote ViewLog Service**. A dialog box appears.
3. Type the GV-Video Server's IP address, login ID and password. Keep the default port **5552** or modify it if necessary.

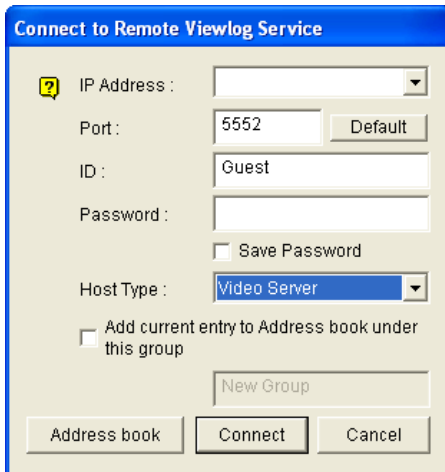

Figure 5-3

4. In the Host Type field, select **Video Server**.
5. Click **Connect** to access the files of the GV-Video Server for playback.

For DST (Daylight Saving Time) events, a separate DST subfolder will be displayed as illustrated below.

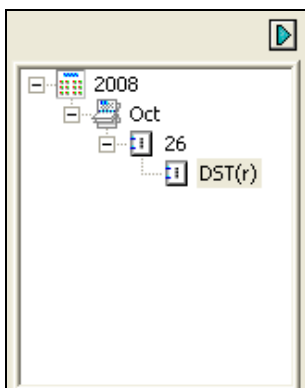

Figure 5-3-1

Note: The AVI file recorded during the DST period is named with the prefix “GvDST”, e.g. GvDST20081022xxxxxxxxx.avi, to differentiate from the regular AVI file named with the prefix “Event”, e.g. Event20081022xxxxxxxxx.avi.

5.2.3 Playback of GPS Tracks

On GV-DVR / NVR, you can retrieve the GPS tracks from GV-Video Server for playback. You can also attach the USB mass storage device with the GPS data to GV-DVR / NVR for playback. To set up GPS tracking on GV-Video Server, see 6.3 *GPS Tracking*.

The following instructions describe how to retrieve the GPS tracks from GV-Video Server over Internet. If you like to use the USB mass storage device for playback, first follow the instructions in 5.2.1 *Playback Using USB Mass Storage Device* to load the data to ViewLog, and then follow Steps 4-7 below to play back GPS tracks.

1. The GV-Video Server must have remote access through **ViewLog Server** activated. See 4.3.8 *ViewLog Server*.
2. To remotely connect to GV-Video Server from GV-DVR / NVR, click the **Tools** button and select **Remote ViewLog Service**. The Connect to Remote ViewLog Service dialog box appears.
3. Enter the connection information of the GV-Video Server, and click **Connect**. Once the connection is established, the video events will be displayed on the Video Events list.
4. To select a map API (Application Program Interface), click the **Tools** button and click **Select Map API**. This dialog box appears.

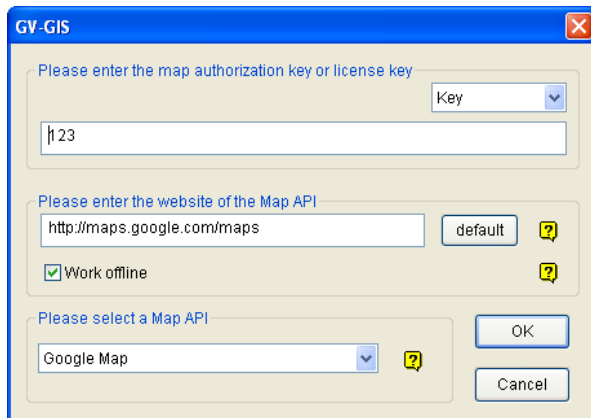

Figure 5-4

5. In **Please Select a Map API**, select a Map API. For Google Maps, you need to sign up for an API key from Google website (<http://code.google.com/apis/maps/signup.html>), and enter the API key in the **Please enter the map authorization key or license key** field.

6. To play back GPS tracks, click the **Tools** button and select **Display GIS Window**. The first-time user will be prompted for a License Agreement. Read through the license terms before you click **I understand and agree** to continue.
7. Select the events with GPS tracks from the Video Event list, select the desired video mode, and click the **Play** button to start.

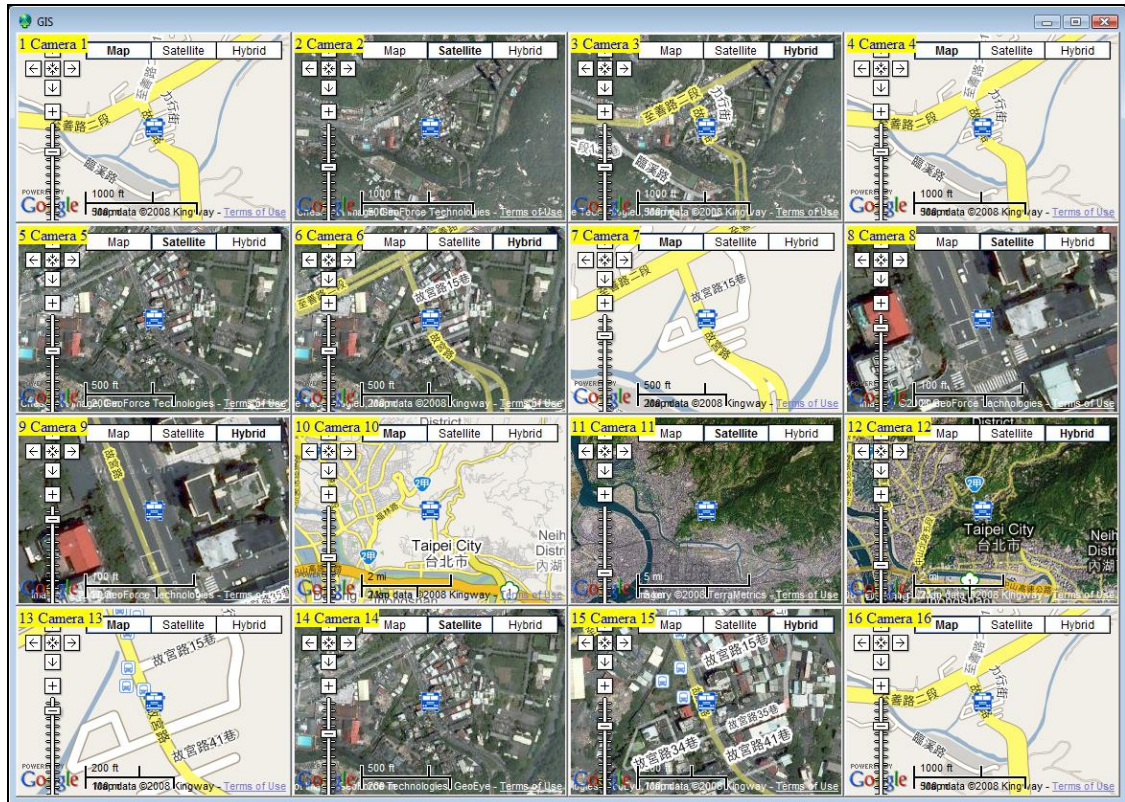

Figure 5-5

Note:

1. The GPS function is only available for GV-VS04H / 12 / 14.
2. For the versions compatible with the playback function by connecting GV-Video Server to GV-DVR / NVR, see *CH7 DVR / NVR / VMS* for details.
3. If you like to use the maps created yourself, overwrite the files at
 :\\GV folder\\GIShtm-User, and select **User Defined** from the “Please Select a Map API” drop-down list (Figure 5-4).
4. If you are a paid-client of Google Maps, select **Client** from the “Please enter the map authorization key or license key” drop-down list; otherwise select **Key**.

Chapter 6 Advanced Applications

This chapter introduces more advanced applications.

6.1 Upgrading System Firmware

GeoVision will periodically release the updated firmware on the website. The new firmware can be simply loaded into the GV-Video Server by using the Web interface or installing the **GV-IP Device Utility** from <http://www.geovision.com.tw/download/product/>.

Important Notes before You Start

Before you start updating the firmware, please read these important notes:

1. While the firmware is being updated, make sure of the following:
 - A. The power supply must not be interrupted.
 - B. The Ethernet cable must not be unplugged if the cable is the source of power supply (Power over Ethernet or PoE supported).
2. Do not turn the power off within 10 minutes after the firmware is updated.

WARNING: The interruption of power supply during updating causes not only update failures but also damages to your GV-Video Server. In this case, please contact our sales representatives and send your device back to GeoVision for repair.

IMPORTANT: After upgrading the firmware of GV-Video Server to the latest version, it is required to **format the storage device** for better recording efficiency and stability. To format the storage device, be sure to back up the data first and see *4.8.3 Storage Settings* for how to format the storage device.

6.1.1 Using the Web Interface

1. In the Live View window, click the **Show System Menu** button (No. 11, Figure 3-3), select **Remote Config**. This dialog box appears.

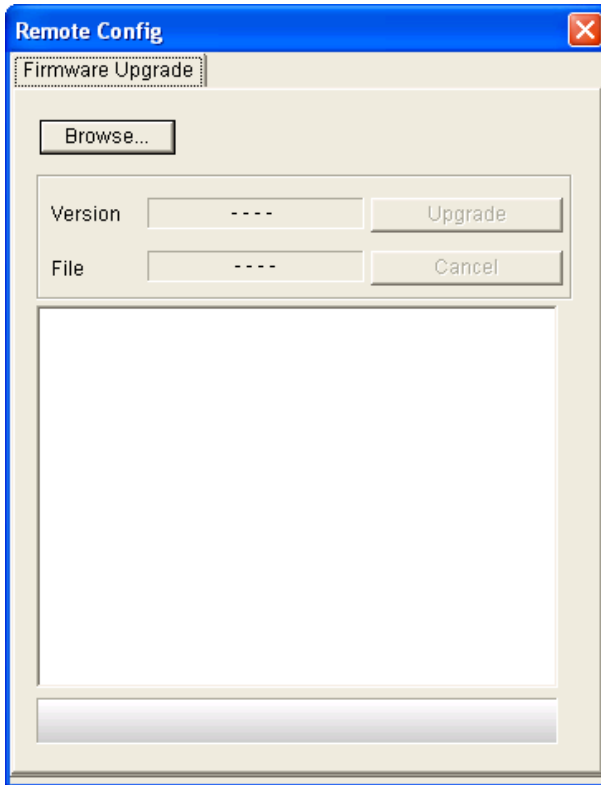

Figure 6-1

2. Click the **Browse** button to locate the firmware file (.img) saved at your local computer.
3. Click the **Upgrade** button to start upgrading.

6.1.2 Using the IP Device Utility

The IP Device Utility provides a direct way to upgrade the firmware to multiple GV-Video Servers.

1. Install the GV-IP Device Utility program from GeoVision download page:
<http://www.geovision.com.tw/download/product/>.
2. Double-click the **GV IP Device Utility** icon created on your desktop. This dialog box appears.

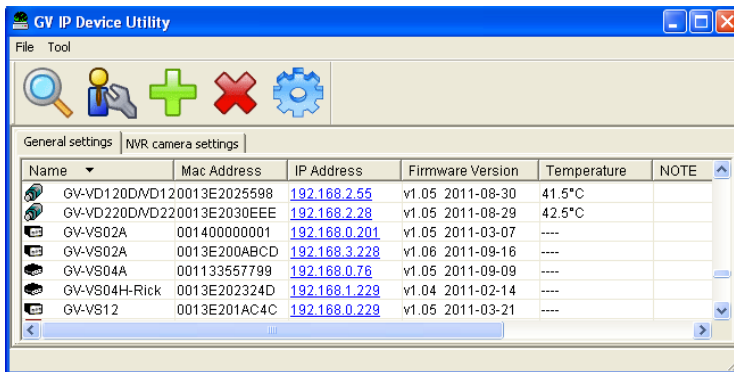



Figure 6-2

3. Click the **Search** button  to locate the available GV-Video Servers on the same LAN. Or click the **New** button  and assign the IP address to locate a GV-Video Server over the Internet. Or highlight one GV-Video Server in the list and click the **Delete** button to remove it.
4. Double-click one GV-Video Server in the list. This dialog box appears.

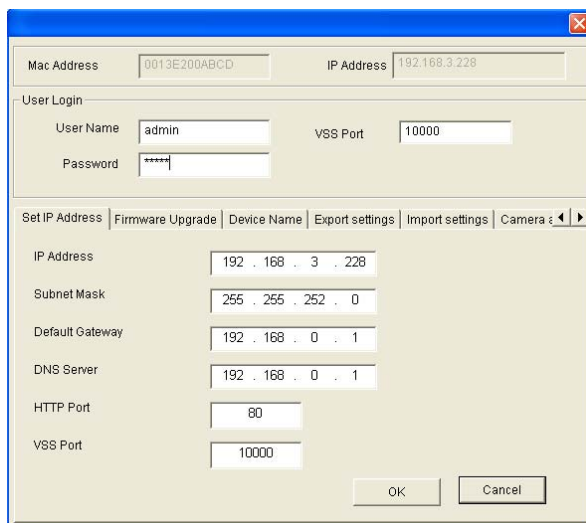

Figure 6-3

5. Click the **Firmware Upgrade** tab. This dialog box appears.

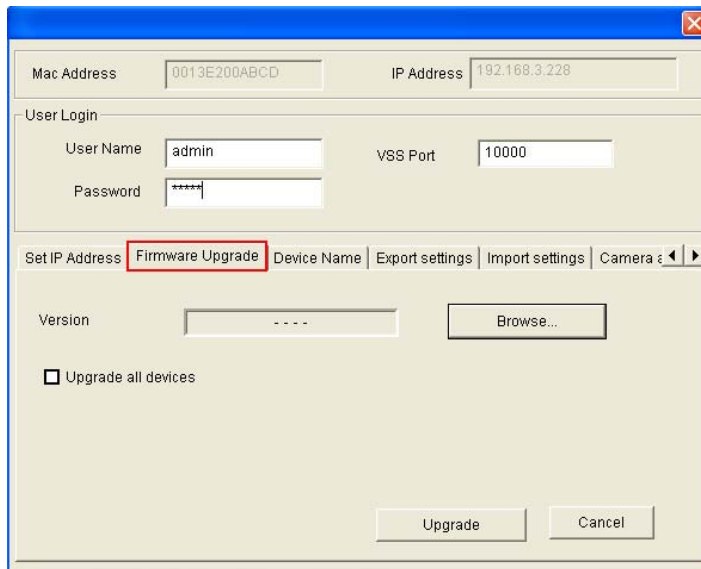

Figure 6-4

6. Click the **Browse** button to locate the firmware file (.img) saved at your local computer.
7. If you like to upgrade all the GV-Video Servers in the list, check **Upgrade all devices**.
8. Type the **Password**, and click **Upgrade** to process the upgrade.

6.2 Backing Up and Restoring Settings

With the IP Device Utility, you can back up the configurations in the GV-Video Server, and restore the backup data to the current unit or import it to another unit.

6.2.1 Backing Up the Settings

1. Run **IP Device Utility** and locate the desired GV-Video Server. See Steps 1-3 in 6.1.2 *Using the IP Device Utility*.
2. Double-click the GV-Video Server in the list. Figure 6-3 appears.

3. Click the **Export Settings** button. This dialog box appears.

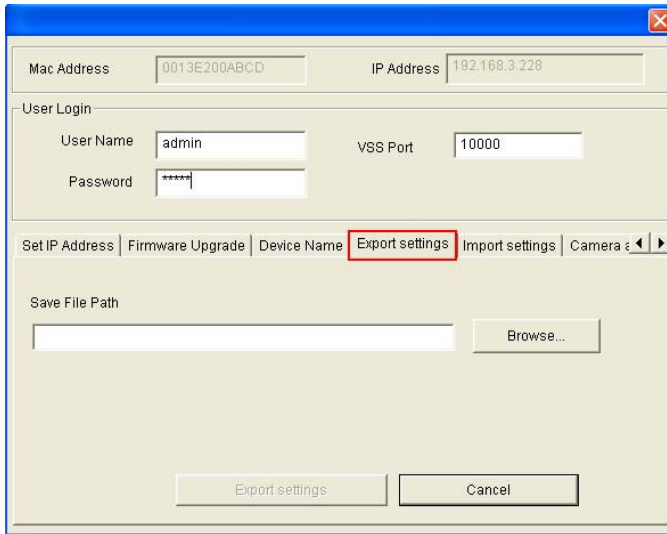

Figure 6-5

4. Click the **Browse** button to assign a file path.
5. Type **Password** and click **Export Settings** to save the backup file.

6.2.2 Restoring the Settings

1. In Figure 6-3, click the **Import Settings** tab. This dialog box appears.

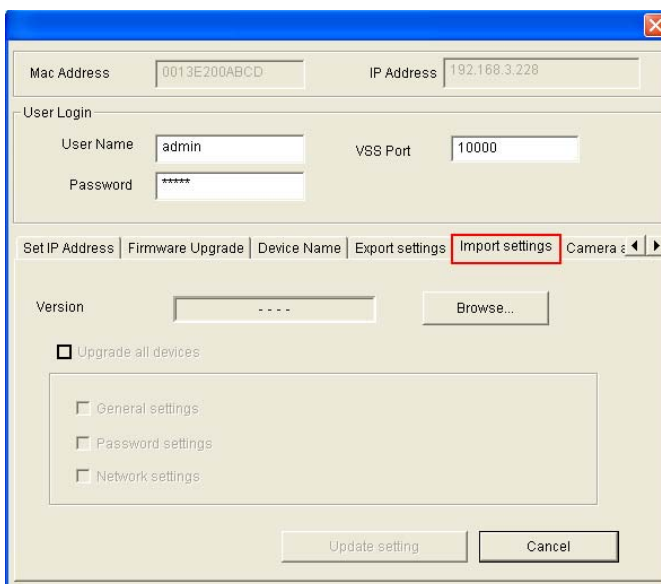

Figure 6-6

2. Click the **Browse** button to locate the backup file (.dat).
3. Click **Update Settings** to start restoring.

6.3 GPS Tracking

Note this function is only available for **GV-VS04H / 12 / 14**.

The GV-Video Server supports the Global Position System (GPS) for active vehicle tracking and location verification. The vehicle location will be tracked by Google Maps.

To track the location of your GV-Video Server:

1. Connect the GV-GPS module or any GPS module to the terminal block on the rear panel of the unit. See *Chapter 9 Auxiliary Device Connectors*.
2. Enable the GPS function. See *4.2.3 GPS/Wiegand*.
3. Sign up for a Google Maps API key and enable the GPS Maps settings. See *4.8.2 GPS Maps Settings*.
4. Open the control panel of the Live View window.



Figure 6-7

- Click **Start** to activate GPS tracking. The longitude, latitude and host time of the GV-Video Server will be displayed.
- To save the location information to your local computer, select **Save message** and click [...] to assign the storage path.

- To track the GV-Video Server on Google Maps, click **Open**. A warning message appears.

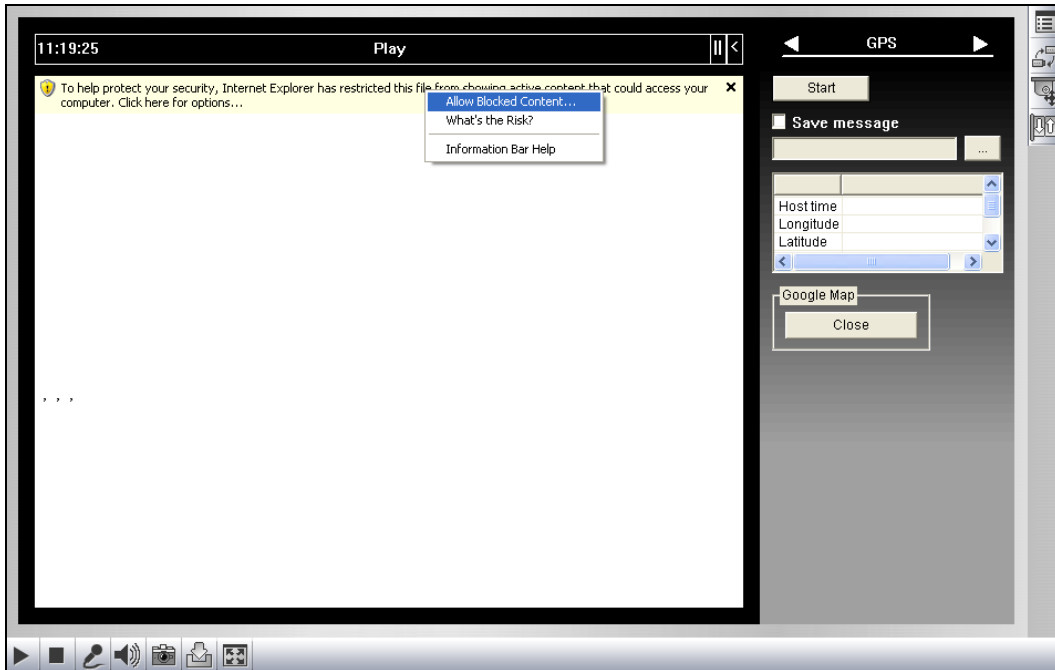

Figure 6-8

- Right-click the warning message and select **Allow Blocked Content**. The map will be displayed. The  icon indicates the location of your GV-Video Server. At the upper right corner you have options for viewing different map formats, such as Satellite and Hybrid.



Figure 6-9

6.4 Restoring to Factory Default Settings

Among different models of GV-Video Server, the operation of restoring the GV-Video Server to original default values can vary and the way the LEDs flash can also be different. To restore to default settings, use the **Reset** and **Load Default** buttons on the front panel. For the location of the two buttons see *1.7 Physical Description*.

GV-VS04H / 14

1. Press and then release the **Reset** button immediately.
2. Press and hold the **Load Default** button until all 3 LEDs (Power, Ready and Disk Full/Fault) are on. This may take up to 30 seconds.
3. Release the **Load Default** button. The process of loading default values is complete, and the GV-Video Server starts rebooting itself with all 3 LEDs turned off.
4. Wait until the Power and Ready LEDs turn on again. After this all the settings are returned to default values.

GV-VS11 / 12

1. Unplug and plug the power cable to start.
2. Press and hold the **Default** button until the Ready LED blinks. This may take up to 30 seconds. The Ready LED will blink twice.
3. Release the **Default** button. The process of loading default values is complete, and the GV-Video Server starts rebooting itself with the 2 LEDs turned off.
4. Wait until the Power and Ready LEDs turn on again. After this all the settings are returned to default values.

GV-VS2420 / 2400 / 2401 / 2820 / 2800 / 21600

1. Press and hold the **Default** button until the Ready LED blinks. This may take up to 10 seconds. The Ready LED will blink twice.
2. Release the **Default** button. The process of loading default values is complete, and the GV-Video Server starts rebooting itself with the Ready LED turned off.
3. Wait until the Ready LED turns on again. After this all the settings are returned to default values

Note: Before the **Ready LED** is on again, do not unplug the power cable; otherwise the loading of default values will fail.

6.5 Verifying Watermark

Note this function is only available for **GV-VS04H** (Firmware Version V1.03 or later), **GV-VS11 / 12** (Firmware Version V1.02 or later) and **GV-VS14 / 2420 / 2400 / 2401 / 2820 / 2800 / 21600**.

The watermark is an encrypted and digital signature embedded in the video stream during the compression stage, protecting the video from the moment of creation. Watermarking ensures that an image is not edited or damaged after it is recorded. To enable the watermark function, see [Watermark], *4.1.2 Video Settings*.

The **Watermark Proof** is a watermark-checking program. It can verify the authenticity of the recording before you present it in court.

6.5.1 Accessing AVI Files

To verify watermark, first you have to access the recorded AVI files by one of these methods:

1. Use the **File Save** function on the Live View window (Figure 3-3) to start recording on the local computer.
2. Use the **Act as FTP Server** function to download AVI files from the GV-Video Server. See *4.3.2 FTP*.
3. Use the files recorded on the USB storage device. Since the files saved on the USB storage device are of Linux file system, remember to run **ExtFS** program to convert the Linux-based files to Windows-based files. For the instructions, see *5.2.1 Playback Using USB Mass Storage Device*.

6.5.2 Running Watermark Proof

1. Install **Watermark Proof** from <http://www.geovision.com.tw/download/product/>. After installment, a **WMPProof** icon is created on your desktop.
2. Double-click the created icon. The Water Mark Proof window appears.
3. Click **File** from the menu bar, select **Open** and locate the recorded file (.avi). The selected file is then listed on the window. Alternatively, you can drag the file directly from the storage folder to the window.
4. If the recording hasn't been tampered with, a check will appear on the **Pass** column; otherwise a check will appear on the **Failed** column. To play back the recording, double-click the listed file on the window.

6.5.3 The Watermark Proof Window



Figure 6-10

The controls in the window:

No.	Name	Description
1	Open File	Opens the recorded file.
2	First Frame	Goes to the first frame of the file.
3	Play	Plays the file.
4	Previous Frame	Goes to the previous frame of the file.
5	Next Frame	Goes to the next frame of the file.
6	Previous Watermarked Frame	Goes to the previous frame that contains watermark.
7	Next Watermarked Frame	Goes to the next frame that contains watermark.
8	Original vs. Extracted	The Extracted icon should be identical with the Original icon. If not, it indicates the recording has been tampered with.
9	File List	Displays the proof results.

Chapter 7 DVR / NVR / VMS

The GV-DVR / NVR / VMS can integrate digital videos from GV-Video Server and provides a full range of video management functions and features, such as video viewing, recording, playback, alert settings and more. Following is the list of the integration specifications:

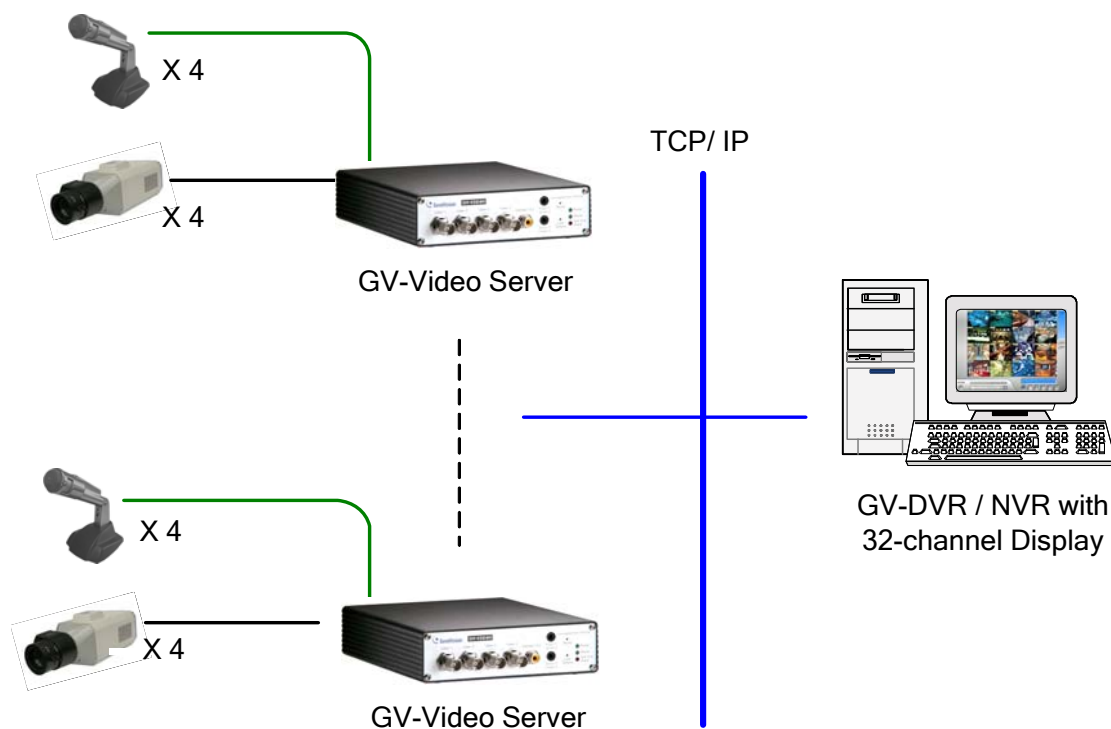

Figure 7-1 GV-DVR / NVR

- The compatible versions of GV-DVR / NVR / VMS for each model:

Model	Compatible version of GV-DVR / NVR	Compatible version of GV-VMS
GV-VS04H	8.4.3 or later	14.10
GV-VS11	8.5.3 or later	
GV-VS12	8.3.2 or later	
GV-VS14	8.5.5 or later	
GV-VS2420 / 2400	8.6.2 with patch files or later	15.10 or later
GV-VS2820 / 2800	8.6.2 with patch files or later	16.10.3.0 or later
GV-2401 / 21600	8.7.4 with patch files or later	16.11.0.0 or later

The maximum number of streams that a GV-Video Server allows is 8 (GV-VS04H) / 16 (GV-VS14, GV-VS2420 / 2400 / 2401 / 2820 / 2800 / 21600) / 4 (GV-VS11 / 12). For **GV-VS04H / 12**, when a channel is connected to GV-DVR / NVR / VMS, IE browser, or any other application, it takes up 1 stream. For **GV-VS11 / 14 / 2420 / 2400 / 2401 / 2820 / 2800 / 21600** with dual-stream function applied, when a channel is connected to IE browser or any other application, it takes up 1 stream; when a channel is connected to GV-DVR / NVR / VMS, it takes up 2 streams.

Note: When you connect over the maximum number of streams specified above, a warning message “Too many users” will pop up, and no image can be accessed after the threshold.

- The codec and recording resolution of digital videos are set up on the GV-Video Server instead of on the GV-DVR / NVR / VMS.
- The hardware compression and the “Pre-Recording Using RAM” feature cannot work on the videos from GV-Video Server. For details about the “Pre-Recording Using RAM” feature, see “System Configuration”, Chapter 1, *GV-DVR User’s Manual*

7.1 Setting Up GV-Video Server on GV-DVR / NVR

To set up the cameras from the GV-Video Server on the GV-DVR / NVR, follow these steps:

1. On the main screen, click the **Configure** button, select **System Configure**, select **Camera Install** and click **IP Camera Install**. This dialog box appears.

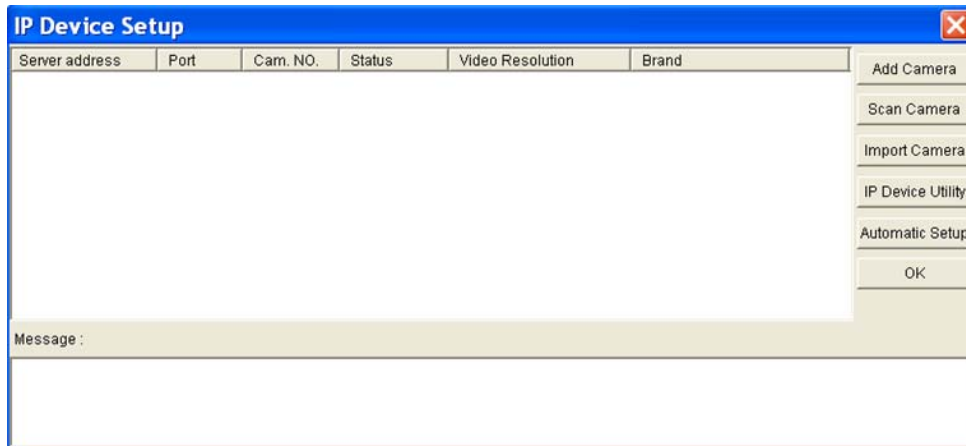

Figure 7-2

- To add an IP camera from a list of the IP cameras on the LAN, click **Scan Camera**.
 - To manually set up an IP camera, follow steps 2 to 7.
2. Click **Add Camera**. This dialog box appears.



Figure 7-3

3. Type the IP address, username and password of the GV-Video Server. Modify the default HTTP port if necessary. Select **GeoVision** from the **Brand** drop-down list and select the GV-Video Server model from the **Device** drop-down list. The following dialog box appears.

For GV-VS04H / 12:

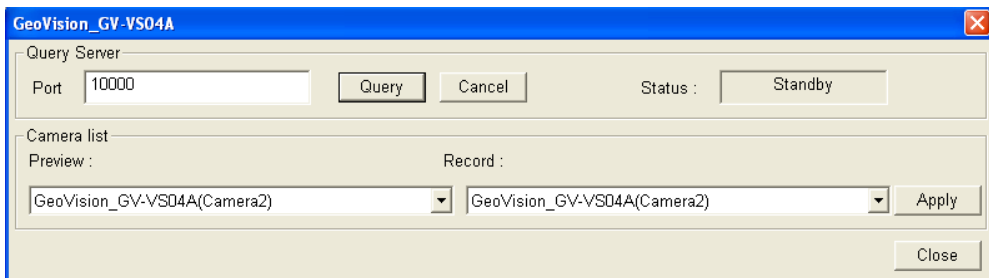

Figure 7-4

- A. Click **Query** to detect the GV-Video Server. When it is detected, its available camera options will be displayed in the Camera List section.
- B. Select the camera for live view from the **Preview** drop-down list, and the camera for recording from the **Record** drop-down list.
- C. Click **Apply** to add and click **Close** to exit the dialog box.

For GV-VS11 / 14 / 2420 / 2400 / 2401 / 2820 / 2800 / 21600:

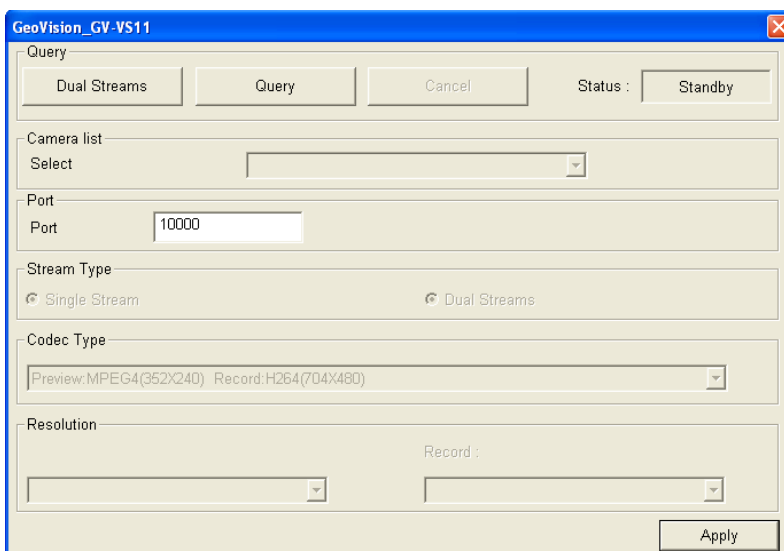

Figure 7-5

- A. The GV-DVR / NVR will automatically query for the GV-Video Server, and the status will be indicated as “Standby”.
- Take GV-VS11 for example, if it is in a **single stream**, you can see one resolution and codec for Preview and Record in Code Type field.
 - Take GV-VS14 for example, if you want to enable **dual streams**, click the **Dual Stream** button to set up the H.264 codec and 704 x 480 resolution for recording and the MPEG4/MJPEG codec and 352 x 240 for live viewing.
- B. Click **Apply**. The camera from the GV-Video Server is added to the list.

Note: If the GV-Video Server is not being detected, modify the HTTP port (Figure 7-3) and streaming port (Figure 7-4 or Figure 7-5) to match those of the IP camera, and click the **Query** button to detect the IP camera again.

4. Click the listed IP camera, and select **Display position** to map the IP camera to a channel on the GV-DVR / NVR.

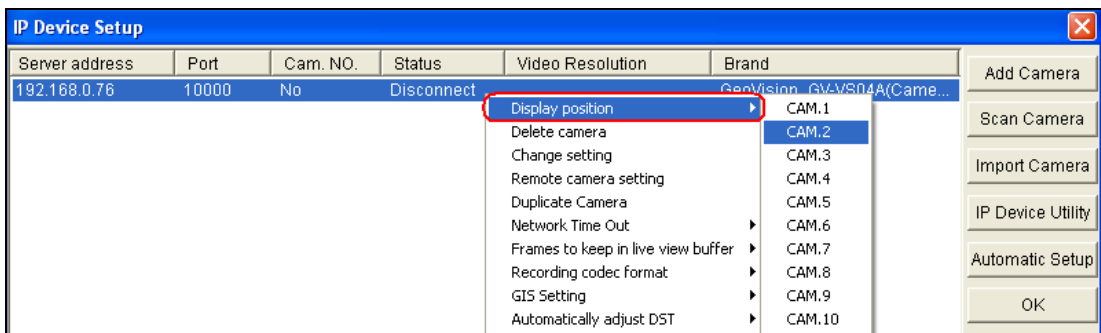

Figure 7-6

5. The Status column now should display “Connected”. Click **OK**.

7.1.1 Customizing GV-Video Server Settings

After the GV-Video Server is connected and assigned with a display position, you can configure the GV-Video Server's settings such as frame rate or resolution. Right-click the desired GV-Video Server to see the following list of options:

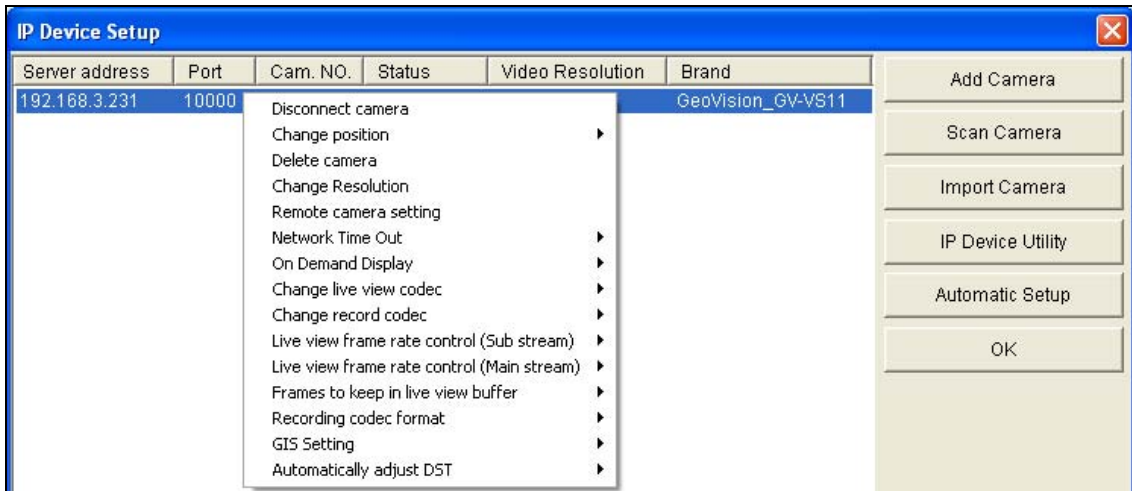

Figure 7-7



- **Change Resolution:** Note this function is only available for **GV-VS11**. Changes the live view and record resolutions based on the display ratio of NTSC (3:2).
- **Network Time Out:** When network disconnection exceeds the specified time period, the video server status will be displayed as Connection Lost.
- **On Demand Display:** Note this function is only available for **GV-VS11**. Enables automatic adjustment of live view resolution. For details, see “On Demand Display”, Chapter 1, *GV-DVR User’s Manual*.
- **Change Live View Codec:** Note this function is only available for **GV-VS11**. Changes the live view codec.
- **Change Record Codec:** Note this function is only available for **GV-VS11**. Changes the recording codec.
- **Live-view frame rate control (Sub stream):** Note this function is only available for **GV-VS11 / 14 / 2420 / 2400 / 2401 / 2820 / 2800 / 21600**. Sets the live view frame rate of the sub stream to help reduce the CPU usage. If you have set the live view codec to be JPEG, select the number of frames to allow in a second. If the live view codec selected is MPEG4 or H.264, select one of the following options:
 - **Maximum Live-view Frame Rate:** View the video at the maximum frame rate possible.

- **Live-view Key Frame only:** You can choose to view the key frames of the videos only instead of all frames on the live view. This option is related to the GOP setting of the IP camera. For example, if the GOP value is set to 30, there is only one key frame among 30 frames.
- **Live-view frame rate control (Main stream):** Sets the live view frame rate of the main stream with higher resolution when On Demand function is enabled. Refer to Live-view frame rate control above to see the options available.
- **Frames to keep in live view buffer:** Specifies the number of frames to keep in the live view buffer.
- **Recording Codec Format:** Specifies whether to record in standard or GeoVision type of MJPEG, MPEG4 or H.264 codec.
- **GIS Setting:** Note this function is only available for **GV-VS04H / 12 / 14**. Records the video with the GPS data. To record the GPS data, remember to also enable the GIS function of the GV-DVR / NVR (Configure button < Accessories < Enable Local GIS).
- **Automatically Adjust DST:** If enabled, the time on the GV-IP device Web interface will be synchronized with the time of the GV-DVR / NVR when DST period starts or ends on the GV-DVR / NVR.

7.2 Setting Up GV-Video Server on GV-VMS

To set up the cameras from the GV-Video Server on the GV-VMS, follow these steps:

Note: The following instructions are based on GV-VMS V14.10 software and user interfaces.

1. To access the IP Device Setup page, click **Home** , select **Toolbar** , click **Configure**  and select **Camera Install**.

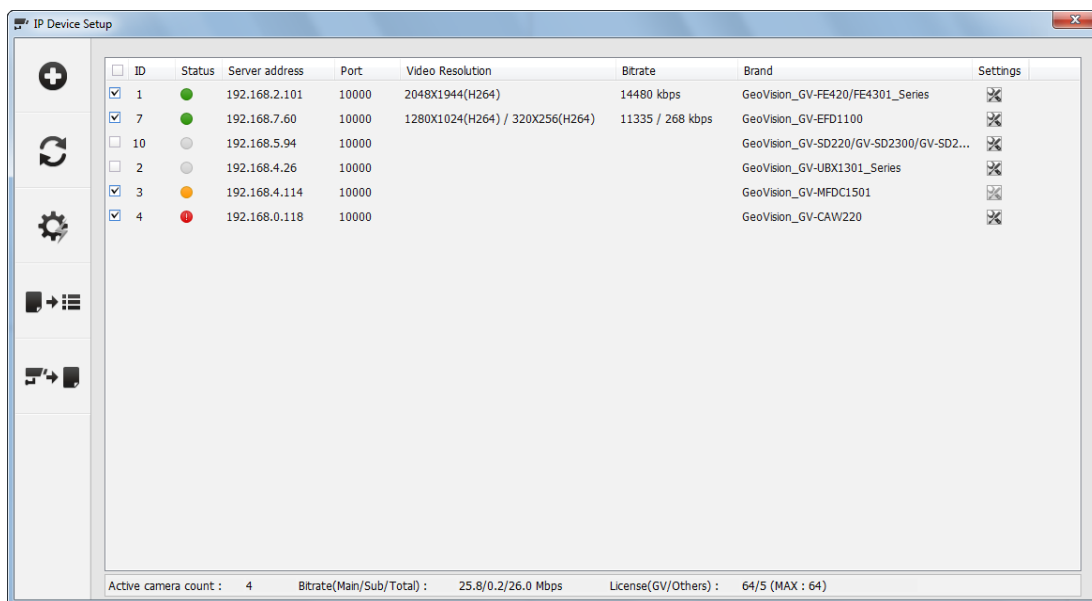

Figure 7-8

2. Click **Add Camera** . This dialog box appears.

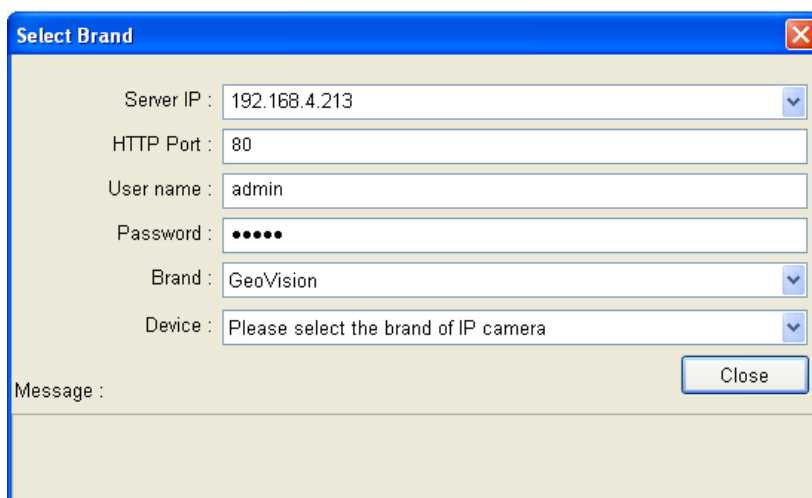

Figure 7-9

3. Type the IP address, username and password of the GV-Video Server. Modify the default HTTP port **80** if necessary. Select **GeoVision** and model name from the **Brand** drop-down list and select the GV-Video Server model from the **Device** drop-down lists. The following dialog appears.

For GV-VS04H / 12:

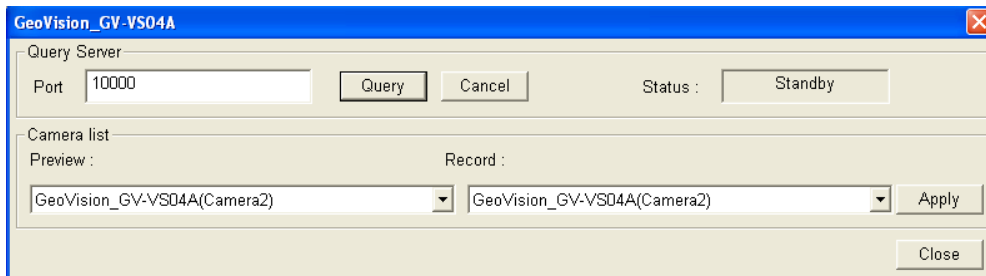

Figure 7-10

- A. Click **Query** to detect the GV-Video Server. When it is detected, its available camera options will be displayed in the Camera List section.
- B. Select the camera for live view from the **Preview** drop-down list, and the camera for recording from the Record drop-down list.
- C. Click **Apply** to add and click **Close** to exit the dialog box.

For GV-VS11 / 14 / 2420 / 2400 / 2401 / 2820 / 2800 / 21600:

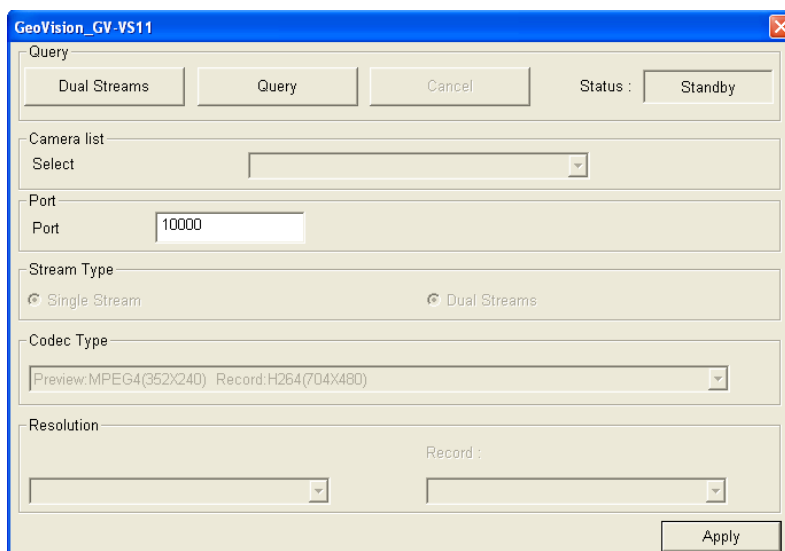

Figure 7-11

- A. The GV-VMS will automatically query for the GV-Video Server, and the status will be indicated as “Standby”.

- Take GV-VS11 for example, if it is in a **single stream**, you can see one resolution and codec for Preview and Record in Code Type field.
 - Take GV-VS14 for example, if you want to enable **dual streams**, click the **Dual Stream** button to set up the H.264 codec and 704 x 480 resolution for recording and the MPEG4/MJPEG codec and 352 x 240 for live viewing.
- B. Configure the other options in the dialog box.
- **Query:** Detect and apply the current codec and resolution setting on the camera. This function may not be available for some third-party cameras.
 - **Camera list:** Select a camera number.
 - **Port:** Modify the video streaming port number if necessary.
 - **Stream Type:** You may have the option of **Single Stream** or **Dual Streams** depending on camera models.
 - **Codec Type:** You may have different codec options depending on camera models. If the selected camera supports dual streaming, the live view codec and recording codec can be set differently.
 - **Resolution:** You may select the different resolutions for live view and recording.
- C. Click **Apply** to add the camera from the GV-Video Server is added to the IP Device list.

Note: If the GV-Video Server is not being detected, modify the HTTP port (Figure 7-9) and streaming port (Figure 7-10 or Figure 7-11) to match those of the IP camera, and click the **Query** button to detect the IP camera again.

4. To connect the added camera, click the box besides the **ID** column. Upon successful connection, the **Status** icon shows green, with the video resolution and bit rate being displayed in the correspondent columns.

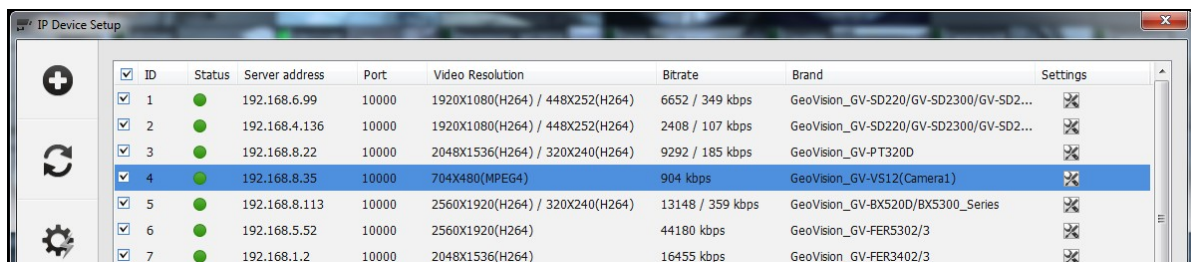

ID	Status	Server address	Port	Video Resolution	Bitrate	Brand	Settings
1	●	192.168.6.99	10000	1920X1080(H264) / 448X252(H264)	6652 / 349 kbps	GeoVision_GV-SD220/GV-SD2300/GV-SD2...	⊗
2	●	192.168.4.136	10000	1920X1080(H264) / 448X252(H264)	2408 / 107 kbps	GeoVision_GV-SD220/GV-SD2300/GV-SD2...	⊗
3	●	192.168.8.22	10000	2048X1536(H264) / 320X240(H264)	9292 / 185 kbps	GeoVision_GV-PT320D	⊗
4	●	192.168.8.35	10000	704X480(MPEG4)	904 kbps	GeoVision_GV-VS12(Camera1)	⊗
5	●	192.168.8.113	10000	2560X1920(H264) / 320X240(H264)	13148 / 359 kbps	GeoVision_GV-BX520D/BX5300_Series	⊗
6	●	192.168.5.52	10000	2560X1920(H264)	44180 kbps	GeoVision_GV-FER5302/3	⊗
7	●	192.168.1.2	10000	2048X1536(H264)	16455 kbps	GeoVision_GV-FER3402/3	⊗

Figure 7-12

7.3 Receiving Cardholder Data from Video Server

This function is only available for **GV-VS04H / 14**. Over the network, GV-DVR / NVR can receive cardholder data from the Wiegand-interface card reader. This transmission is made possible through GV-Video Server.

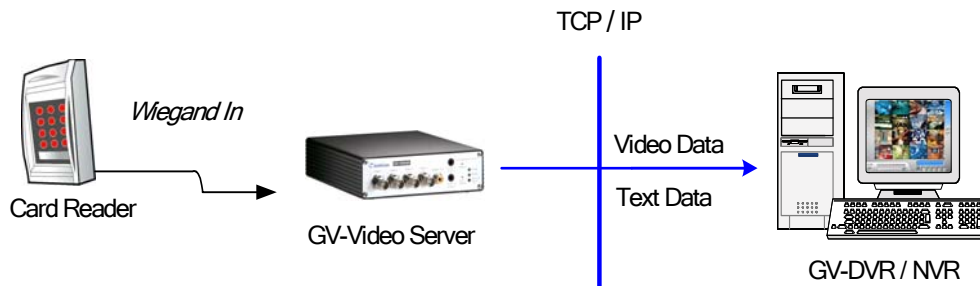

Figure 7-13

Note: The function is not supported by GV-VMS.

To receive cardholder data from Video Server, follow these steps:

1. Add the GV-Video Server to the GV-DVR / NVR. See *7.1 Setting Up GV-Video Server*.
2. Click the **Configure** button, point to **Accessories** and select **GV Wiegand Capture Device Setting**. The GV-Wiegand Capture Setup dialog box appears.
3. Click the **New** button. This dialog box appears.

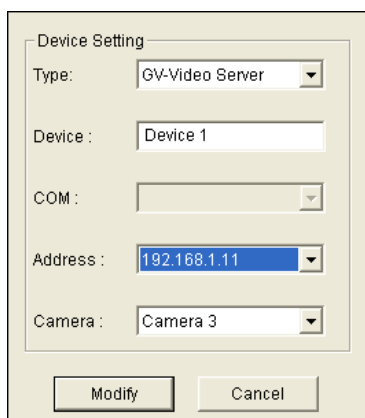
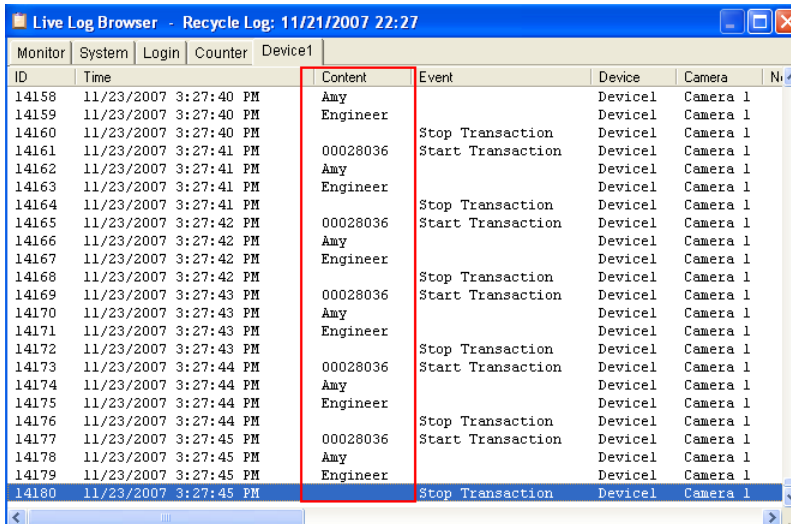

Figure 7-14

4. Select **GV-Video Server** from the **Type** drop-down list, enter a descriptive name for the Video Server, select the IP address of the video server from the Address drop-down list and select the camera to be mapped with.

5. Click **Add** to add the Wiegand card reader to the system.
6. Note the cardholder data will not be overlaid on the mapped camera. To view cardholder data, click the **ViewLog** button, select **System Log** to display the Live Log Browser and click the **Device** tab.



ID	Time	Content	Event	Device	Camera	Nr
14158	11/23/2007 3:27:40 PM	Amy		Device1	Camera 1	
14159	11/23/2007 3:27:40 PM	Engineer		Device1	Camera 1	
14160	11/23/2007 3:27:40 PM		Stop Transaction	Device1	Camera 1	
14161	11/23/2007 3:27:41 PM	00028036	Start Transaction	Device1	Camera 1	
14162	11/23/2007 3:27:41 PM	Amy		Device1	Camera 1	
14163	11/23/2007 3:27:41 PM	Engineer		Device1	Camera 1	
14164	11/23/2007 3:27:41 PM		Stop Transaction	Device1	Camera 1	
14165	11/23/2007 3:27:42 PM	00028036	Start Transaction	Device1	Camera 1	
14166	11/23/2007 3:27:42 PM	Amy		Device1	Camera 1	
14167	11/23/2007 3:27:42 PM	Engineer		Device1	Camera 1	
14168	11/23/2007 3:27:42 PM		Stop Transaction	Device1	Camera 1	
14169	11/23/2007 3:27:43 PM	00028036	Start Transaction	Device1	Camera 1	
14170	11/23/2007 3:27:43 PM	Amy		Device1	Camera 1	
14171	11/23/2007 3:27:43 PM	Engineer		Device1	Camera 1	
14172	11/23/2007 3:27:43 PM		Stop Transaction	Device1	Camera 1	
14173	11/23/2007 3:27:44 PM	00028036	Start Transaction	Device1	Camera 1	
14174	11/23/2007 3:27:44 PM	Amy		Device1	Camera 1	
14175	11/23/2007 3:27:44 PM	Engineer		Device1	Camera 1	
14176	11/23/2007 3:27:44 PM		Stop Transaction	Device1	Camera 1	
14177	11/23/2007 3:27:45 PM	00028036	Start Transaction	Device1	Camera 1	
14178	11/23/2007 3:27:45 PM	Amy		Device1	Camera 1	
14179	11/23/2007 3:27:45 PM	Engineer		Device1	Camera 1	
14180	11/23/2007 3:27:45 PM		Stop Transaction	Device1	Camera 1	

Figure 7-15

For the related settings on the GV-Video Server, see *Wiegand Function* in 4.2.3 *GPS/Wiegand*.

7.4 Remote Monitoring with Multi View

You can use the Multi View to monitor and manage the cameras and I/O devices connected to the GV-Video Server. This function is only available for GV-VS04H / 11 / 12 / 14.

Note: Multi View is not supported by GV-VMS.

Connecting to GV-Video Server

The Multi View program is available in the GV-DVR / NVR applications, as well as on the GeoVision Website as an independent program. The following is an example of running the Multi View through WebCam Server on the GV-DVR / NVR.

1. To enable the remote access to the GV-DVR / NVR, click the **Network** button, select **WebCam Server** to display the Server Setup dialog box, and click **OK** to start the WebCam server.
2. At the local computer, open the Web browser and type the address of the GV-DVR / NVR. The Single View page appears.
3. Select **Multi View** and the desired viewing resolution. The valid user name and password are required for login. For the first-time user, you will be directed to the Download page. Install the Multi View program before you can run it.
4. On the Multi View window, click the **Edit Host** button. The Edit Host window appears.
To create a host, click the **New** button. You need to create a group before creating a host.

5. Select **GV-Video Server** from the Device drop-down list. Type the host name, IP address, user name and password of the GV-Video Server. Modify the default VSS port **10000** if necessary.

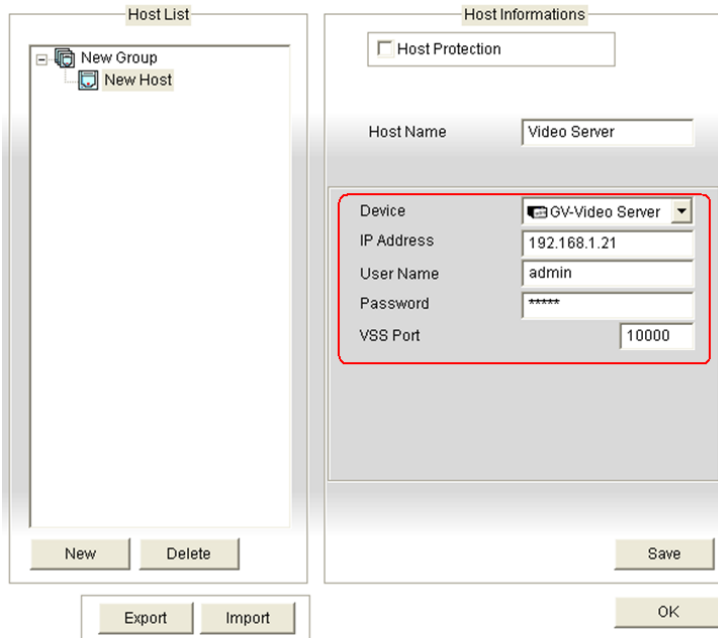

Figure 7-16

6. Click **Save** to establish connection.

For details on the Multi View functions, see “Multi View Viewer”, Chapter 8, *GV-DVR User’s Manual*.

7.5 Remote Monitoring with E-Map

You can use the Remote E-Map to monitor and manage the cameras and I/O devices connected to the GV-Video Server.

Creating an E-Map for the GV-Video Sever

With the E-Map Editor, you can create an E-Map for the cameras and I/O devices connected to the GV-Video Server. The E-Map Editor is available in the two applications: Main System and E-Map Server. The following is an example of running the E-Map Editor included in the Main System.

1. Go to Windows **Start** menu, point to **Programs**, select **GV folder** and click **E-Map Editor**.
2. To create an E-Map, click the **Add Map** button on the toolbar. A New Map file appears.

3. Double-click the New Map file, and click the **Load Map** button on the toolbar to import a graphic file.
4. To create a host, click the **Add Host** button on the toolbar and select **Add Video Server**.
5. Right-click the created New Host in the Host View and select **Host Settings**. This dialog box appears.

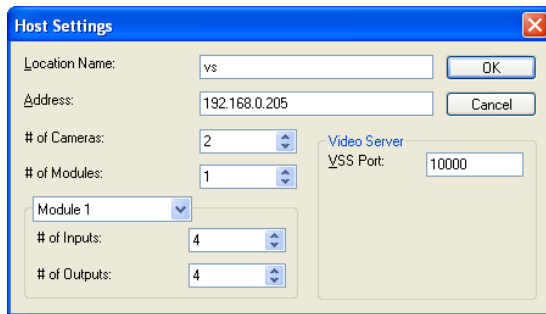

Figure 7-17

6. Give the GV-Video Server a location name, and type its IP address (or domain name). Keep the default VSS port **10000**, or modify it to match that of GV-Video Server.
7. Click **OK** to save the settings.
8. Expand the created host folder. Drag and drop the icons of cameras and I/O devices onto the imported E-Map.
9. Close the E-Map Editor. Click **Yes** when you are prompted to save the file.

For details on creating an E-Map file on the E-Map Server, see “E-Map Application”, *GV-DVR User’s Manual* or *GV-VMS User’s Manual*.

Connecting to GV-Video Server

Depending on where you save the created E-Map file (GV-DVR / NVR / VMS, E-Map Server or Control Center), the steps to open the Remote E-Map window for monitoring may vary slightly. The following is a connection example if you store the E-Map file in the GV-DVR / NVR.

1. To enable the remote access to the GV-DVR / NVR / VMS, click the **Network** button, select **WebCam Server** to display the Server Setup dialog box, and click **OK** to start the WebCam server.
2. At the local computer, open the Web browser and type the address of the GV-DVR / NVR / VMS. The Single View page appears.

3. Select **Emap**. The valid user name and password are required for login. For the first-time user, you will be directed to the Download page. Install the E-Map program before you can run it.
4. On the Remote E-Map window, click the **Login** button and select the GV-Video Server host to access its videos and I/O devices. The valid user name and password are required to log in the GV-Video Server.

For details on the Remote E-Map functions, see “E-Map Applications”, *GV-DVR User’s Manual* or *GV-VMS User’s Manual*.

Chapter 8 CMS Configurations

This section introduces the related settings to enable connecting to the GV-Video Server in the central monitoring stations Center V2, Vital Sign Monitor and Dispatch Server.

8.1 Center V2

The Center V2 can monitor and manage the cameras and I/O devices connected to the GV-Video Server.

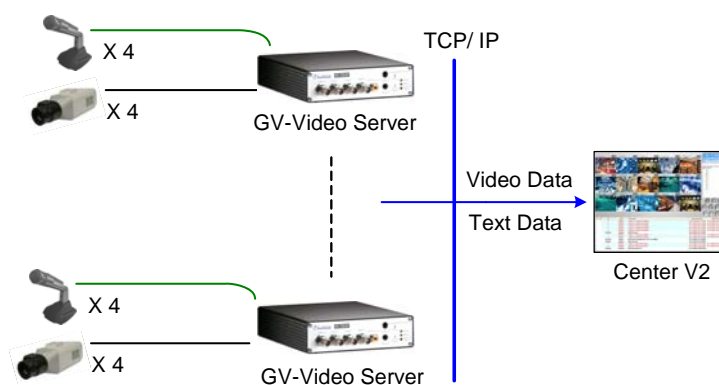

Figure 8-1

- To set the appropriate port connecting to the GV-Video Server, click the **Preference Settings** button, select **System Configure**, click the **Network** tab, and check **Accept connections from GV-Compact DVR, Video Server & IP Cam**. Keep the default port **5551** for the Port 2 option, or modify it to match the Center V2 port on the GV-Video Server.

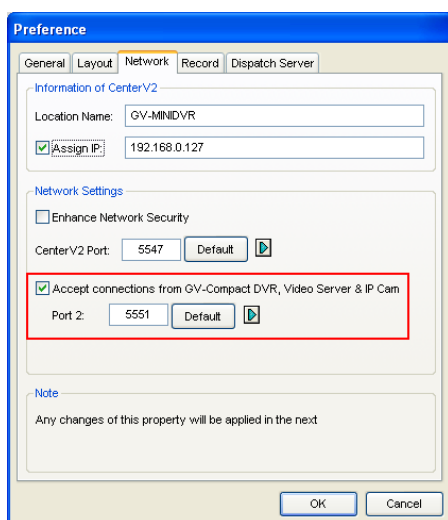

Figure 8-2

To define how to display the received video on motion detection and input trigger from the GV-Video Server, click the **Preference Setting** button and select **System Configure**. This dialog box appears.

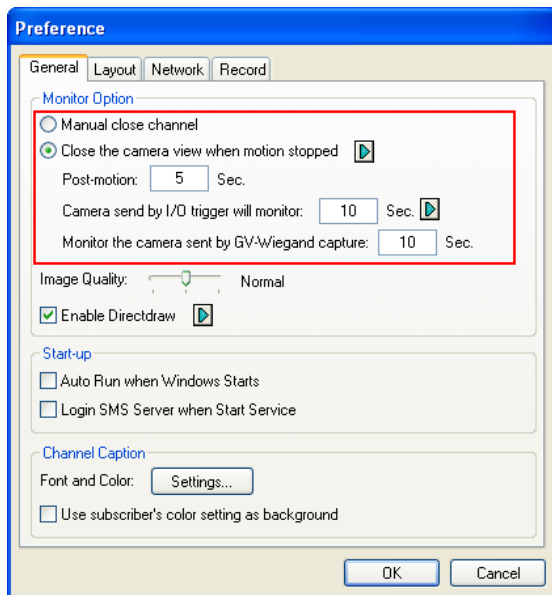

Figure 8-3

- **Manual close channel:** Closes the triggered camera view manually.
- **Close the camera view when motion stopped:** Closes the triggered camera view automatically when motion stops.
- **Post Motion:** Specify the duration of the camera view remaining on the monitoring window after motion stops.
- **Camera send by I/O trigger will monitor:** Specify the duration of the camera view remaining on the monitoring window when an I/O device is triggered.

To keep the camera view remaining on the monitoring window even after the alarm is finished, click the right-arrow button, and uncheck **Latch Trigger**. Then the camera view will remain on the monitoring window for the specified time. For example, if the alarm is triggered for 5 minutes and you set 10 minutes, the camera view will be displayed for 15 minutes.

- **Monitor the camera sent by GV-Wiegand Capture:** Specify the duration of the camera view remaining on the monitoring window when the card reader, connected to GV-Video Server, is triggered. For the related Wiegand settings on the GV-Video Server, see *4.2.3 GPS / Wiegand*.

For further information on how to manage the received video from the GV-Video Server, see *GV-CMS Series User's manual*.

8.2 Vital Sign Monitor

The Vital Sign Monitor is designed to monitor and manage the cameras and I/O devices connected to the GV-Video Server under low bandwidth network.

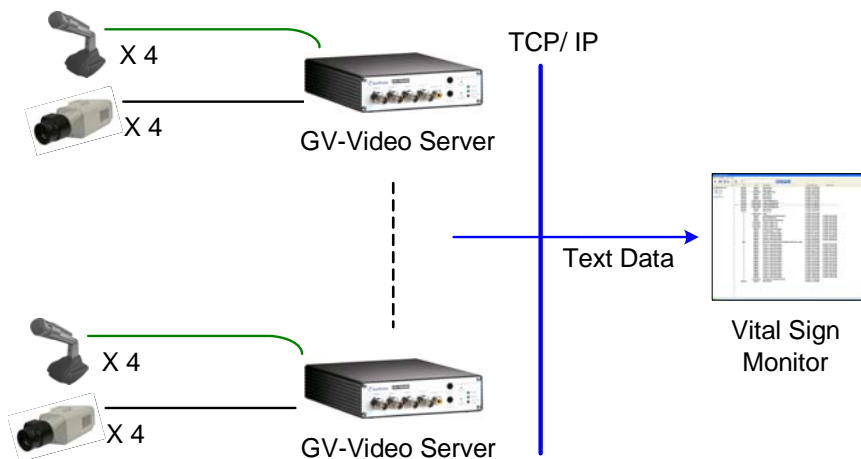

Figure 8-4

- To set the appropriate port connecting to the GV-Video Server, click **Configure** on the window menu, and select **System Configure** to display this dialog box. In the Connective Port field, keep the default value **5609** for the Port 2 option, or modify it to match the Vital Sign Monitor port on the GV-Video Server.

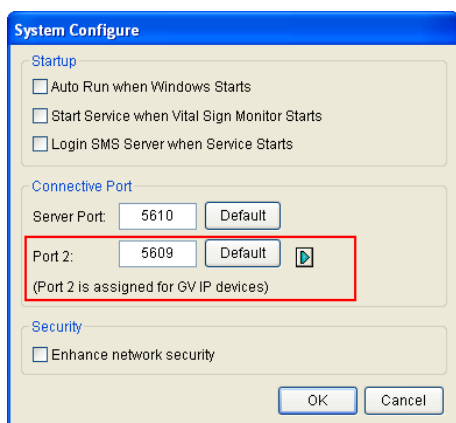

Figure 8-5

For further information on how to manage the video received from the GV-Video Server, see *GV-CMS Series User's manual*.

8.3 Dispatch Server

The Dispatch Server minimizes overloading of Center V2 Servers by re-distributing GV-Video Server subscribers to the least busy Center V2 server.

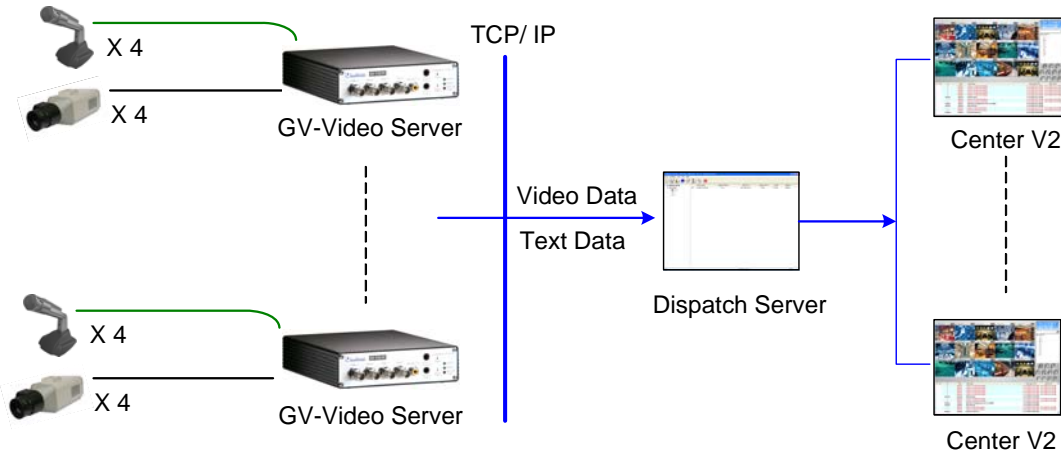

Figure 8-6

- To set the appropriate port connecting to the GV-Video Server, click the **Server Setting** button on the toolbar, and enable **Allow GV IP devices to login as subscriber from port**. Keep the default port **5551**, or modify it to match the Center V2 port on the GV-Video Server.

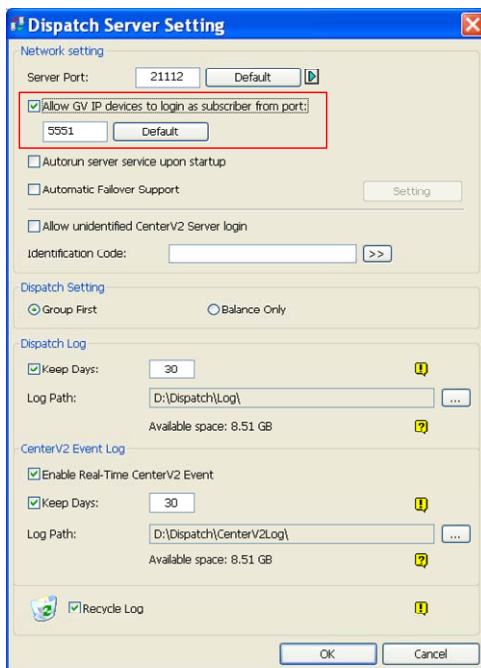

Figure 8-7

For further information on how to manage the received video from the GV-Video Server, see *GV-CMS Series User's manual*.

Chapter 9 Auxiliary Device Connectors

9.1 GV-VS04H / 14 / 2420 / 2400 / 2401 / 2820 / 2800 / 21600

GV-VS04H / 14 / 2420 / 2400 / 2401

The 16-pin terminal block, located on the rear panel, provides interfaces for four digital inputs, four relay outputs, an RS-485 interface, a Wiegand interface, a GPS interface or auxiliary power. The terminal block can be used to develop applications for motion detection, event alerts via E-mail and FTP, center monitoring by Center V2 and Vital Sign Monitor, PTZ control or Wiegand-interface card reader, and a variety of other functions.

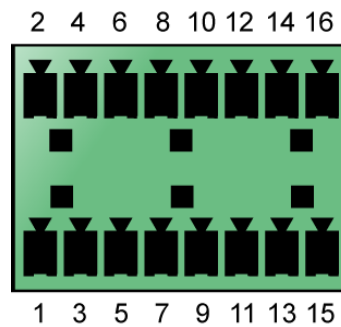

Figure 9-1

GV-VS2820 / 2800 / 21600

The 24-pin terminal block, located on the rear panel, provides interfaces for eight digital inputs, eight digital outputs, an RS-485 interface and auxiliary power. The terminal block can be used to develop applications for motion detection, event alerts via E-mail and FTP, center monitoring by Center V2 and Vital Sign Monitor, PTZ control and a variety of other functions.

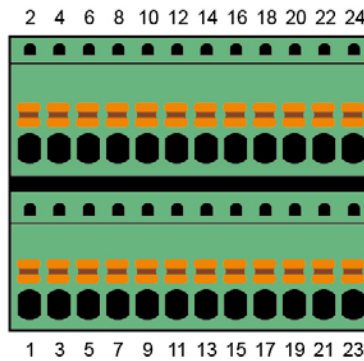

Figure 9-2

9.1.1 Pin Assignment

The table below lists the pin assignment for the terminal block.

GV-VS04H / 14

Pin	Function	Pin	Function
1	Relay Output 1	9	DC 5V Out for GV-Relay Module, or GPS Module
2	Digital Input 1	10	Ground, or GPS Ground
3	Relay Output 2	11	RS 485+
4	Digital Input 2	12	Wiegand D0, or GPS RX
5	Relay Output 3	13	RS 485-
6	Digital Input 3	14	Wiegand D1, or GPS TX
7	Relay Output 4	15	Ground
8	Digital Input 4	16	DC 12V Out for Wiegand Card Reader

Note: To connect the GPS module, use Pin 9 for power supply, Pin 10 for ground, Pin 12 for GPS RX and Pin 14 for GPS TX.

GV-VS2420 / 2400 / 2401

Pin	Function	Pin	Function
1	Digital Output 1	9	DC 5V Out for GV-Relay Module
2	Digital Input 1	10	Ground
3	Digital Output 2	11	RS 485+
4	Digital Input 2	12	N/A
5	Digital Output 3	13	RS 485-
6	Digital Input 3	14	N/A
7	Digital Output 4	15	Ground
8	Digital Input 4	16	DC 12V Out

GV-VS2820 / 2800 / 21600

Pin	Function	Pin	Function
1	Digital Output 1	13	Digital Output 7
2	Digital Input 1	14	Digital Input 7
3	Digital Output 2	15	Digital Output 8
4	Digital Input 2	16	Digital Input 8
5	Digital Output 3	17	Ground
6	Digital Input 3	18	Ground
7	Digital Output 4	19	DC 5V Out for GV-Relay Module
8	Digital Input 4	20	RS 485+
9	Digital Output 5	21	Ground
10	Digital Input 5	22	RS 485-
11	Digital Output 6	23	DC 12V Out
12	Digital Input 6	24	Ground

9.1.2 Relay Output

The relay outputs on the terminal block only drives a maximum load of 5 volts. Working in conjunction with the GV-Relay V2 module, it is capable of driving heavier loads. Refer to the figure and table below to connect the GV-Relay V2 module to the GV-Video Server.

Note: The GV-Relay module is an optional product.

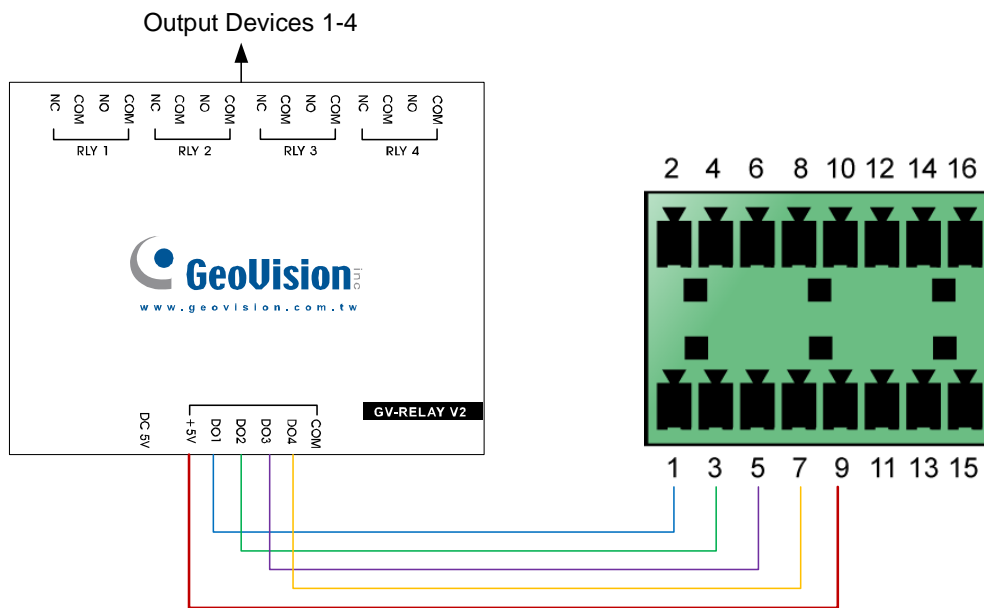

Figure 9-3

GV-Relay V2	I/O Terminal Block
DO 1	Pin 1
DO 2	Pin 3
DO 3	Pin 5
DO 4	Pin 7
+ 5V	Pin 9

Note that you don't need to use the DC 5V connector on the GV-Relay V2 module for power supply, since the power is supplied from the GV-Video Server.

9.2 GV-VS11

The terminal block on the rear panel of GV-VS11 provides one digital input and output, an RS-485 interface and auxiliary power.

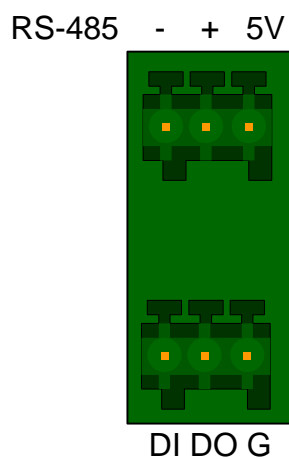

Figure 9-4

Pin	Function
RS-485-	RS-485-
RS-485+	RS-485+
5V	DC 5V Out
DI	Digital Input
DO	Digital Output
G	Ground

9.3 GV-VS12

Owing to the model size, GV-VS12 provides **I/O Cable with RJ-45 Connector** for extensible connection to other I/O devices and PTZ cameras. A RJ-45 connector and a bundle of shielded wires are on each end of the cable.

Strip the desired wires first, and connect the auxiliary devices with the right wires according to the following pin assignment in section 9.2.1. Then insert the RJ-45 Connector to the I/O/PTZ Port on GV-VS12 (No. 4, Figure 1-9).

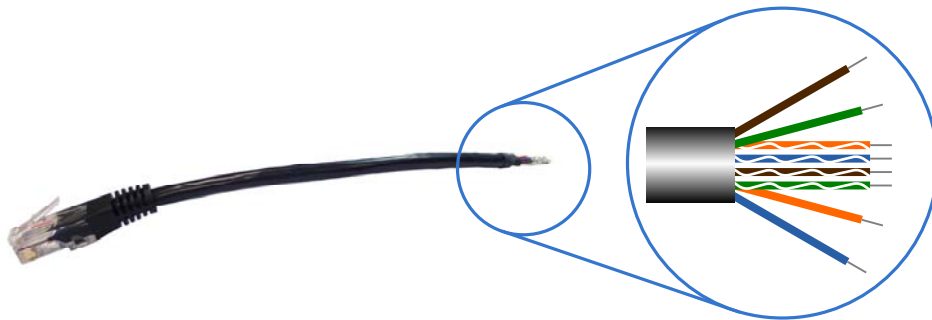

Figure 9-5

9.3.1 Pin Assignment

The table below lists the pin assignment for the shielded wires of the I/O Cable with RJ-45 Connector.

Pin	Wire	Function
1	Brown	Digital Out 1
2	White with Brown Stripe	Digital Out 2
3	White with Green Stripe	Ground
4	White with Blue Stripe	Digital In 1
5	Blue	Digital In 2
6	Green	Ground
7	Orange	RS-485 -
8	White with Orange Stripe	RS-485 +

9.3.2 RS-232 Terminal Block

The RS-232 terminal block on GV-VS12 is mainly used for connecting to a GPS module.

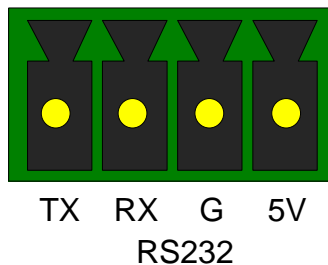

Figure 9-6

Pin	Function
TX	GPS RX (Receive)
RX	GPS TX (Transmit)
G	Ground
5V	DC 5V Out

Note: To ensure the connection to the GV-VS12, the GPS RX must be connected to the TX pin, and the GPS TX must be connected to the RX pin.

Chapter 10 Mobile Phone Connection

With mobile phones capable of GPRS, 3G and Wi-Fi, you can receive live videos from your GV-Video Server using GV-Eye V2.0 or later. To download the latest GV-Eye or see the full installation guide, visit <http://www.geovision.com.tw/products.php?c2=147>.

Appendix

A. Settings for Internet Explore 8 or later

If you use Internet Explorer 8 or later, it is required to complete the following setting.

1. Set the Security to **Medium-high (default)**.
2. Enable **Allow previously unused ActiveX controls to run without prompt**.
3. Disable **Only allow approved domains to use ActiveX without prompt**.

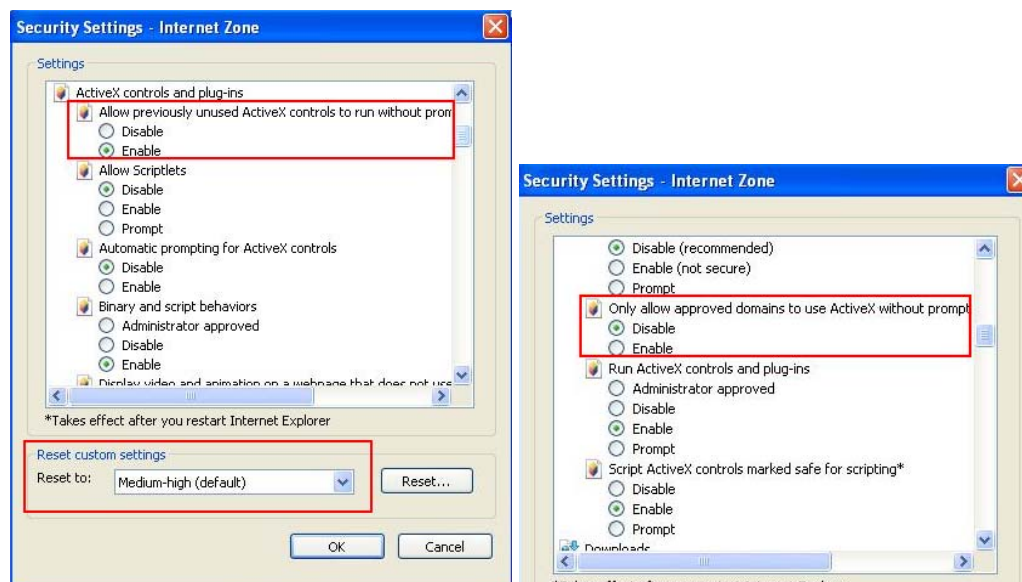

B. Supported Wireless LAN USB Adaptor

GV-VS04H / 12 / 14 / 2420 / 2400 / 2401 / 2820 / 2800 / 21600

Vendor	Model
D-Link	DWA-140 (H/W version B1), DWL-G122 (version C1)
Edimax	EW-7318Ug, EW-7318Un, EW-7718Un, EW-7711UAn
Linksys	WUSB54GC, WUSB600 (version 1)
Pegatron	WL-166N11

Note: Linksys WUSB54GC ver. 3 is not supported.

GV-VS11

Vendor	Model
Edimax	EW-7711UAn
Pegatron	WL-166N11

C. Supported Mobile Broadband Device

GV-VS04H / 12 / 14 / 2420 / 2400 / 2401 / 2820 / 2800 / 21600

Vendor	Model
Bandluxe	C320, C501
D-Link	DWM-222
Huawei	E156, E156B, E169, E220, E1692, E1750, E1752, E1756, E1756C, EC169C, EC189 USB Modem (HSDPA/UMTS/EDGE/GPRS/GSM), E398
Novatel	MC950D, MC996D, MC998D (HSDPA/UMTS/EDGE/GPRS/GSM)
Onda	MSA523HS
Sierra	250U
Verizon	USB727, USB728, USB760 Modem (EVDO)
Vodafone	K3565 (Rev 2)
ZTE	MF100
<p>Note: D-Link DWM-222 is only supported by GV-VS2420 / 2400 / 2820 / 2800. Huawei E1756C is only supported by GV-VS12 / 14 / 2420 / 2400 / 2401 / 2820 / 2800 / 21600. Huawei E398 is only supported by GV-VS12.</p>	

GV-VS11

Vendor	Model
Huawei	E169, E220, EC169C, E1750, E1756, E1756C, EC189 USB Modem (HSDPA/UMTS/EDGE/GPRS/GSM)
Novatel	MC998D (HSDPA/UMTS/EDGE/GPRS/GSM)

D. The RTSP Command

The GV-Video Server can support RTSP protocol for both audio and video streaming.

If you use QuickTime player, enter:

rtsp://<IP of the GV-Video Server:8554/<CH No.>.sdp

For example, rtsp://192.168.3.111:8554/CH001.sdp

If you use VLC, enter:

rtsp://username:password@<IP of the GV-Video Server:8554/<CH No.>.sdp

For example, rtsp://admin:admin@192.168.3.111:8554/CH001.sdp

Note:

1. The RTSP server must be enabled on the Web interface. See 4.3.9 3GPP / RTSP / ONVIF.
 2. Only VLC and QuickTime players are supported for video streaming via RTSP protocol.
 3. For GV-VS11 and GV-VS12, only 352 x 240 (352 x 288) and 176 x 112 (176 x 144) are supported.
-

E. Supported PTZ Cameras

The following table shows a list of supported PTZ cameras.

PTZ Model and Protocol
AcutVista (SSD-7971D)
Ademco (Jupiter)
Bosch (G3)
Bosch (TC700 / 8560)
Canon (VCC4 / VCC5i)
CBC GANZ (ZC-S120 Series)
Chiper (CPT-V9KRV)
COP (15-CD53W) - Pelco D
COP (15-CD55TW) - Pelco D
COP (15-CD55W) - Pelco D
COP (CD55X) - Pelco D
Direct Perception (PTU Series)
D-max Dome
DongYang Dome (DOH-240)
DynaColor (D-7720 / 7722)
DynaColor Dome
Dynacolor (DynaHawk-ZH701)
ELBEX (Matrix / 1000)
Elmo (PTC-200C)
Elmo (PTC-400C)
Elmo (PTC-1000)
EverFocus (EPTZ 1000 / 500)
Eyeview T-Power (T2-SA27)
GKB (SPD-221)
HiSharp - Pelco D
HiSharp - Pelco P
JEC Dome
JVC (TK-S576B / S655 / C686E)
Kalatel CyberDome
Kampro Technology (K-ZC23)
KenKo (DMP23-H1)
LG (LPT-OS553HQ)
Lilin (PIH) – MLP1

Lilin (PIH-7625) – MLP1
Lilin (PIH-820) – MLP1
MESSOA (SDS600 Series)
MESSOA (D-700 Series)
Minking Dome
Mintron (54G2AHN / P)
NanWang (NVD 2300PNT)
NanWang V4.1 (NVD 2300PNT)
Panasonic (WV-CS850)
Panasonic (WV-CW960)
Pelco Dome
Pelco (Spectra III)
Pelco Spetra Mini Dome (SD4-WO)
Pishion (22X)
PTZ in I/O
RX214D
SAE (DR-E588)
Samsung (SCC-641 / 643)
Samsung (SPD-1600)
Samsung (SPD-3300)
Sensormatic (Ultra IV)
Sony (EVI-D100)
StorVision PTZ
TOA (CC551)
VDI (CT-58SPD)
VIDO.AT Dome
YAAN Dome
360 Vision (ViD-18COP04) - Pelco P

F. The CGI Command

Note this function is only supported by **GV-VS04H** (Firmware Version 1.03 or later), **GV-VS11 / 12** (Firmware Version 1.04 or later) and **GV-VS14 / 2420 / 2400 / 2401 / 2820 / 2800 / 21600**.

You can use the CGI command to obtain a snapshot of the live view or access the User Account Web interface. For GV-Video Server, refer to the following details:

IP address: 192.168.2.11

Username: admin

Password: admin

Desired stream: 1

To obtain a snapshot of the live view, type the following into your Web browser:

<http://192.168.2.11/PictureCatch.cgi?username=admin&password=admin&channel=1>

To access the User Account Web interface, type the following into your Web browser:

<http://192.168.2.11/ConfigPage.cgi?username=admin&password=admin&page=UserSetting>

Note: For GV-VS11 / 12, if the resolution is set as 704 x 480 (704 x 576), the obtained snapshot will be 704 x 240 (704 x 288).

G. Default Port Value

HTTP Port	80
Streaming Port	10000
E-Mail Server	25
FTP Server	21
Center V2	5551
Vital Sign Monitor	5609
GV-GIS	3356
Video Gateway	50000
Backup Center	30000
ViewLog Server	5552
RTSP/TCP Port	8554
RTP/UDP Port	17300 -17319